

**Anritsu** envision : ensure

**VectorStar™**

High Performance, Broadband Network Analysis Solutions

# ME7838E Series Vector Network Analyzers

Broadband VNA System

70 kHz to 110 GHz

Millimeter Waveguide VNA System

50 GHz to 1.1 THz

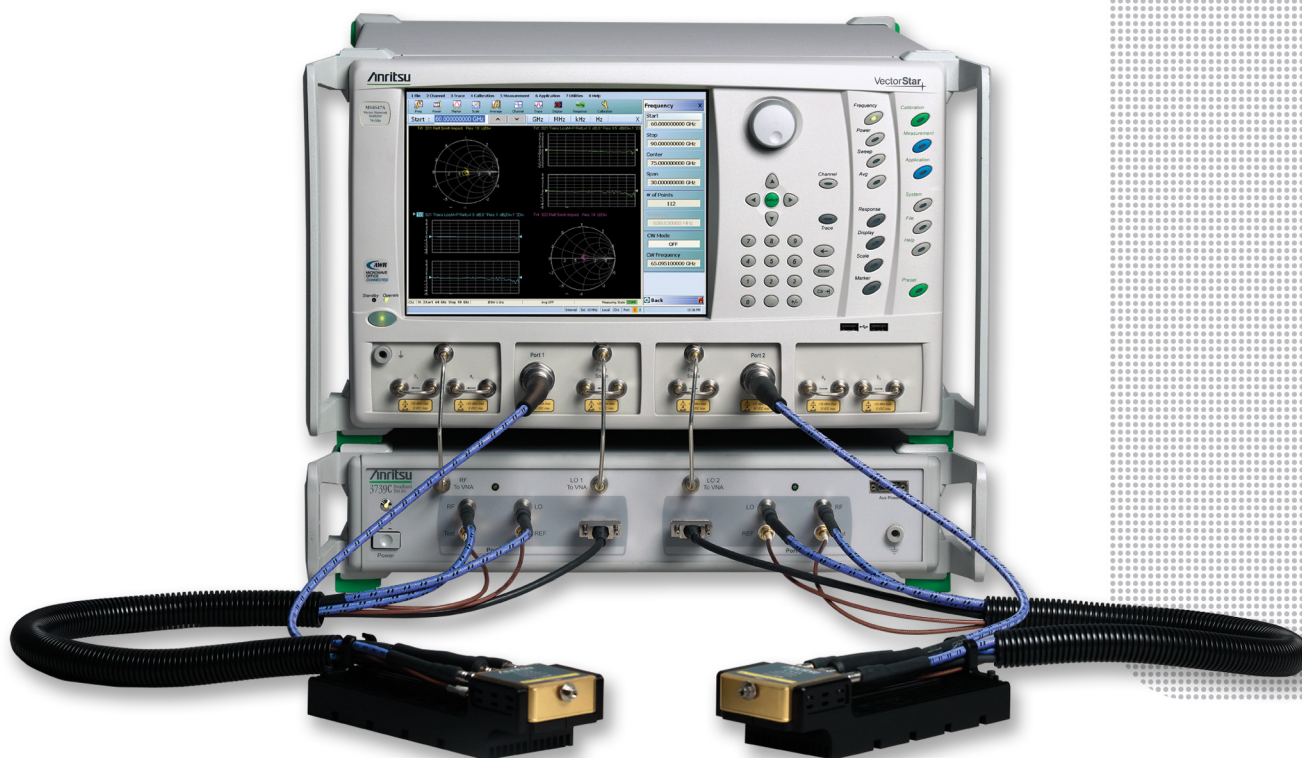

**4TECT**

ООО «4ТЕСТ»

Телефон: +7 (499) 685-4444

info@4test.ru

www.4test.ru

---

## ME7838E Introduction

---

### Broadband VNA System 70 kHz to 110 GHz

The ME7838E Broadband VNA System provides single sweep coverage from 70 kHz to 110 GHz. It consists of the following items:

- MS4647B VectorStar VNA, 70 kHz to 70 GHz with Option 7, Option 70, and Option 86/87 or Option 88/89
  - 3739C Broadband Millimeter-Wave Test Set and Interface Cables
  - 3743E Millimeter-Wave Modules, 2 each
- 

### Millimeter Waveguide VNA System 50 GHz to 1.1 THz

The ME7838E Millimeter-Wave configuration provides waveguide output from 50 GHz to 1.1 THz in waveguide bands. The system can extend the broadband system or be configured to operate only as a waveguide system. It consists of the following items:

- MS464xB VectorStar™ VNA, with Option 7 and Option 86/87 or Option 88/89
  - 3739C Broadband/Millimeter-Wave Test Set and Interface Cables
  - Banded Millimeter-Wave modules, 2 each
- 

### Broadband/Millimeter-Wave System Options

- MS4640B-002 – Time Domain
- MS4640B-021 – Universal Fixture Extraction
- MS464xB-031 – Dual Source Architecture
- MS464xB-032 – Internal RF Combiner
- MS4640B-035 – IF Digitizer
- MS4640B-036 – Extended IF Digitizer Memory
- MS4640B-041 – Noise Figure
- MS4640B-042 – PulseView™
- MS4640B-043 – DifferentialView™
- MS4640B-044 – IMDView™
- MS4640B-046 – Fast CW
- MS4640B-047 – Eye Diagram
- MS4640B-048 – Differential Noise Figure
- MS464xB-051 – External VNA Direct Access Loops
- MS464xB-061 – Active Measurement Suite, with 2 Attenuators
- MS464xB-062 – Active Measurement Suite, with 4 Attenuators
- 3744E-Rx – 30 to 110 GHz mm-Wave Receiver for Noise Figure and mm-Wave Antenna Measurements
- 3744E-EE – 56 to 95 GHz WR-12 Waveguide Module
- 3744E-EW – 65 to 110 GHz WR-10 Waveguide Module
- SC8215 and SC7287 – Kelvin Bias Tees

A detailed color brochure available on the Anritsu web site provides descriptions and examples of the VectorStar family's features and benefits:

(<http://www.anritsu.com/en-us/products-solutions/products/ms4640b-series.aspx>)

Table of Contents

ME7838E Introduction ..... 2  
 Definitions ..... 3  
 Broadband Configuration ..... 4  
 Broadband Specifications ..... 4  
 Broadband Measurement Examples ..... 11  
 Waveguide Band Configuration ..... 16  
 Waveguide Band Specifications ..... 17  
 Millimeter-Wave Noise Figure Measurements with Option 41/48 and 3744E-Rx ..... 22  
 Waveguide Bands from 50 GHz to 1.1 THz ..... 24  
 Standard Capabilities for All Configurations ..... 28  
 Mechanical and Environmental ..... 28  
 Regulatory Compliance ..... 28  
 Warranty ..... 28  
 Calibration and Correction Capabilities ..... 29  
 Mechanical Calibration/Verification Kits ..... 30  
 Test Port Cables ..... 31  
 Precision Adapters, Attenuators, and Other Components ..... 31  
 Ordering Information ..... 32

Definitions

	All specifications and characteristics apply under the following conditions, unless otherwise stated:
Warm-Up Time	After 90 minutes of warm-up time, where the instrument is left in the ON state.
Temperature Range	Over the 25 °C ± 5 °C temperature range.
Error-Corrected Specifications	For error-corrected specifications, over 23 °C ± 3 °C, with < 1 °C variation from calibration temperature. For error-corrected specifications are warranted and include guard bands, unless otherwise stated.
Typical Performance	"Typical" specifications describe expected, but not warranted, performance based on sample testing. Typical performance indicates the measured performance of an average unit and do not guarantee the performance of any individual product. "Typical" specifications do not account for measurement uncertainty and are shown in parenthesis, such as (-102 dB), or noted as Typical.
User Cables/Adapters	Specifications do not include effects of any user cables, adapters, fixtures or other structures attached to the instrument.
Discrete Spurious Responses	Specifications may exclude discrete spurious responses.
Internal Reference Signal	All specifications apply with internal 10 MHz Crystal Oscillator Reference Signal.
Characteristic Performance	Characteristic performance indicates a performance designed-in and verified during the design phase. It does include guard-bands and is not covered by the product warranty.
Below 300 kHz	All uncertainties below 300 kHz are typical.
Recommended Calibration Cycle	12 months
Interpolation Mode	All specifications are with Interpolation Mode Off.
Specifications Subject to Change	All specifications subject to change without notice. For the most current data sheet, please visit the Anritsu web site at <a href="http://www.anritsu.com">www.anritsu.com</a> .

**Broadband Configuration**

**ME7838E Broadband Hardware Configuration**

The ME7838E broadband VNA system provides single sweep coverage from 70 kHz to 110 GHz. It consists of the following items:

VNA	MS4647B VectorStar VNA, 70 kHz to 70 GHz with Option 7, Option 70, and Option 86/87/88/89
Test Set	3739C Broadband Test Set and interface cables
mm-Wave Modules	3743E Millimeter-Wave Modules, 2 each

**ME7838E Broadband/Millimeter-Wave System Options**

The major ME7838E broadband VNA system options are:

Option 2	MS4640B-002 – Time Domain
Option 21	MS4640B-021 – Universal Fixture Extraction
Option 31	MS464xB-031 – Dual Source Architecture
Option 32	MS464xB-032 – Internal RF Combiner
Option 35	MS4640B-035 – IF Digitizer
Option 36	MS4640B-036 – Extended IF Digitizer Memory
Option 41	MS4640B-041 – Noise Figure
Option 42	MS4640B-042 – PulseView™
Option 43	MS4640B-043 – DifferentialView™
Option 44	MS4640B-044 – IMDView™
Option 46	MS4640B-046 – Fast CW
Option 47	MS4640B-047 – Eye Diagram
Option 48	MS4640B-048 – Differential Noise Figure
Option 51	MS464xB-051 – External VNA Direct Access Loops
Option 61	MS464xB-061 – Active Measurement Suite, with 2 Attenuators
Option 62	MS464xB-062 – Active Measurement Suite, with 4 Attenuators
Bias Tees	SC8215 and SC7287 – Kelvin Bias Tees

**Broadband Specifications**

**System and Receiver Dynamic Range, Noise Floor** (Excludes localized spurious responses and crosstalk)

System Dynamic Range	System dynamic range is measured as the difference between maximum port power and the RMS noise floor in a 10 Hz bandwidth and no averaging (ports terminated).
Noise Floor	Noise floor is calculated as the difference between maximum rated port power and system dynamic range.
Receiver Dynamic Range	Receiver Dynamic Range is calculated as the difference between the receiver compression level and the noise floor at Ports 1 or 2.
Normalizing Measurement	Normalizing measurement made with a through line connection, with its effects compensated for. The cables between the VNA and the 3743E modules are assumed to be the part number 806-206-R, 1.85 mm cable (61 cm, 24 in long) or the part number 806-209-R, 1.85 mm cable (91.5 cm, 36 in long). All values are typical.

Frequency Range	System Dynamic Range (dB) <sup>a</sup>		Receiver Dynamic Range (dB) <sup>a</sup>		Noise Floor (dBm) <sup>a</sup>	
	ME7838E	ME7838E Option 62	ME7838E	ME7838E Option 62	ME7838E	ME7838E Option 62
70 to 300 kHz	93	90	89	86	-83	-82
0.3 to 2 MHz	103	100	103	102	-93	-92
2 to 10 MHz	115	112	115	114	-105	-102
0.01 to 2.5 GHz	120	116	121	122	-110	-109
2.5 to 24 GHz	110	105	121	121	-110	-108
24 to 54 GHz	108	105	124	123	-114	-113
54 to 60 GHz	112	112	122	122	-112	-112
60 to 65 GHz	108	108	117	117	-107	-107
65 to 80 GHz	108	108	120	120	-110	-110
80 to 85 GHz	110	110	123	123	-113	-113
85 to 90 GHz	108	108	121	121	-111	-111
90 to 95 GHz	111	111	121	121	-111	-111
95 to 100 GHz	107	107	117	117	-107	-107
100 to 110 GHz	109	109	122	122	-112	-112

a. Excludes localized spurious responses and crosstalk.

**Test Port Power, Receiver Compression<sup>a</sup>**

Port power control is provided by the base VNA for frequencies below 54 GHz, and by the 3743E mm-Wave module for frequencies greater than 54 GHz. Receiver compression point is defined as the port power level beyond which the response may be compressed more than 0.2 dB relative to normalization level. 10 Hz IF bandwidth used to remove trace noise effects. All typical.

Frequency Range	Port Power		Receiver Compression	
	Max Power ME7838E	Max Power ME7838E Option 62 <sup>b</sup>	Compression ME7838E	Compression ME7838E Option 62
70 to 300 kHz	10	8	6	6
0.3 to 2 MHz	10	8	10	12
2 to 10 MHz	10	10	10	12
0.01 to 2.5 GHz	10	7	11	13
2.5 to 24 GHz	0	-3	11	13
24 to 54 GHz	-6	-8	10	10
54 to 60 GHz	0	0	10	10
60 to 65 GHz	1	1	10	10
65 to 80 GHz	-2	-2	10	10
80 to 85 GHz	-3	-3	10	10
85 to 90 GHz	-3	-3	10	10
90 to 95 GHz	0	0	10	10
95 to 100 GHz	0	0	10	10
100 to 110 GHz	-3	-3	10	10

a. Using the 806-206-R, 1.85 mm (61 cm, 24 in long) test port cables between the VNA and the 3743E mm-Wave modules.

b. Use this column also for Options 51 and 61 although the performance between 10 MHz and 54 GHz will characteristically be better by 1 dB or more for Option 51, and will characteristically be better by 1 dB or more for Option 61 (with port 1 driving and port 2 receiving).

**Power Range, Accuracy, Linearity, and Resolution**

Accuracy is defined at -10 dBm or max rated power, whichever is lower. Linearity is defined as the incremental error between the accuracy test power level and 5 dB below. Typical.

Frequency Range	Range (dB)		Accuracy (dB)	Linearity (dB)	Resolution (dB)
	ME7838E	ME7838E Option 62			
70 to 300 kHz	+10 to -25	+8 to -85	±1.5	±1.5	0.01
0.3 to 2 MHz	+10 to -25	+8 to -85	±1.5	±1.5	0.01
2 to 10 MHz	+10 to -25	+10 to -85	±1.5	±1.5	0.01
.01 to 2.5 GHz	+10 to -25	+8 to -85	±1.0	±1.0	0.01
2.5 to 24 GHz	0 to -25	-3 to -85	±1.0	±1.0	0.01
24 to 54 GHz	-6 to -30	-8 to -90	±1.5	±1.0	0.01
54 to 60 GHz	0 to -55	0 to -55	±2.0	±1.5	0.01
60 to 65 GHz	+1 to -55	+1 to -55	±2.0	±1.5	0.01
65 to 80 GHz	-2 to -55	-2 to -55	±2.0	±1.5	0.01
80 to 85 GHz	-3 to -55	-3 to -55	±2.0	±1.5	0.01
85 to 90 GHz	-3 to -55	-3 to -55	±2.0	±1.5	0.01
90 to 95 GHz	0 to -55	0 to -55	±2.0	±1.5	0.01
95 to 100 GHz	0 to -55	0 to -55	±3.0	±2.0	0.01
100 to 110 GHz	-3 to -50	-3 to -55	±3.0	±2.0	0.01

**High Level Noise**

Noise measured at 1 kHz IF bandwidth, at maximum power or compression limit (whichever is less), with through transmission. RMS. Typical.

Frequency (GHz)	Magnitude (dB)	Phase (deg.)
70 to 300 kHz	< 0.04	< 0.4
0.3 to 2 MHz	< 0.005	< 0.05
2 to 10 MHz	< 0.005	< 0.05
0.01 to 2.5	< 0.005	< 0.05
2.5 to 24	< 0.006	< 0.06
24 to 54	< 0.005	< 0.06
54 to 80	< 0.005	< 0.06
80 to 110	< 0.008	< 0.09

**Stability**

Ratioed measurement at maximum leveled power and with nominally a full coaxial reflect or a stable coaxial thru over the normal specified temperature range. Typical.

Frequency (GHz)	Magnitude (dB/°C)	Phase (deg./°C)
70 to 300 kHz	< 0.015	< 0.1
0.3 to 2 MHz	< 0.015	< 0.05
2 to 10 MHz	< 0.01	< 0.05
0.01 to 2.5	< 0.01	< 0.05
2.5 to 30	< 0.01	< 0.09
30 to 54	< 0.01	< 0.07
54 to 80	< 0.015	< 0.1
80 to 110	< 0.015	< 0.15

**Frequency Resolution, Accuracy, and Stability**

Resolution	Accuracy	Stability
1 Hz	$\pm 5 \times 10^{-7}$ Hz/Hz (at time of calibration)	$< 5 \times 10^{-9}/^{\circ}\text{C}$ over 0 °C to 50 °C temperature $< 1 \times 10^{-9}/\text{day}$ aging, instrument on

**Uncorrected (Raw) Port Characteristics**

Typical performance with either ME7838E or ME7838E with Option 62.

Frequency (GHz)	Directivity (dB)	Port Match (dB)
<10 MHz	10 <sup>a</sup>	8
0.01 to 2.5	9 <sup>a</sup>	10
2.5 to 30	5 <sup>a</sup>	12
30 to 40	5 <sup>a</sup>	5
40 to 54	10	5
54 to 80	10	10
80 to 110	5	7

a. Raw directivity is degraded below 300 kHz, 2.2 to 2.5 GHz and in narrow bands within 10 to 34 GHz.

**Corrected System Performance and Uncertainties – SOLT/SSST**

With 12-term concatenated SOLT and Triple Offset Short Calibration (SSST), using the 3656B W1 Calibration Kit. Typical.

Frequency (GHz)	Directivity (dB)	Source Match (dB)	Load Match (dB)	Reflection Tracking (dB)	Transmission Tracking (dB)
70 to 10MHz	36	36	36	± 0.1	± 0.1
0.01 to 2.5	40	41	40	± 0.05	± 0.03
2.5 to 20	40	41	40	± 0.05	± 0.05
20 to 67	38	41	38	± 0.05	± 0.07
67 to 95	37	42	37	± 0.05	± 0.07
95 to 110	35	35	35	± 0.05	± 0.07

**Measurement Uncertainties – SOLT/SSST**

The graphs give measurement uncertainties after the above calibration. The errors are worst case contribution of residual directivity, load and source match, frequency response and isolation, network analyzer dynamic accuracy, and connector repeatability while noise effects are added on an RSS basis. 10 Hz IF Bandwidth is used. For transmission uncertainties, it is assumed that  $S_{11} = S_{22} = 0$ . For reflection uncertainties, it is assumed that  $S_{21} = S_{12} = 0$ . For other conditions, please use our free Exact Uncertainty calculator software, downloadable from the Anritsu web site at [www.anritsu.com](http://www.anritsu.com).

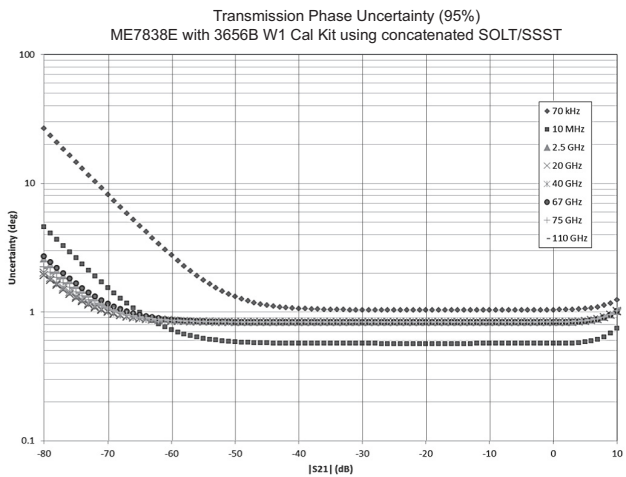
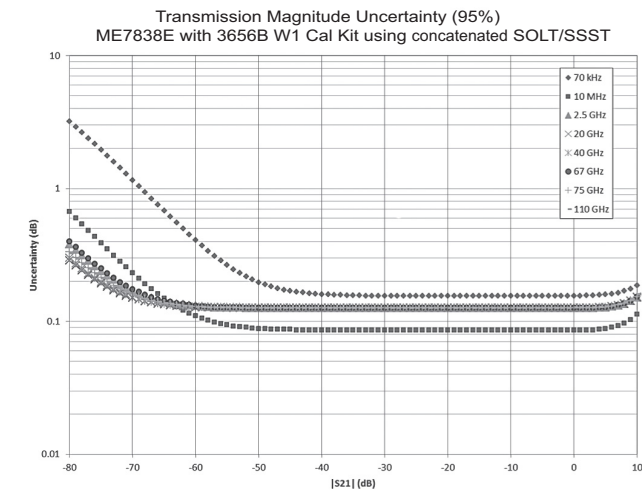
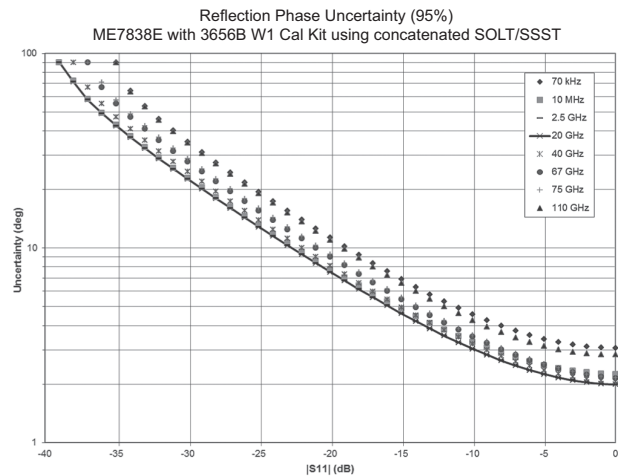
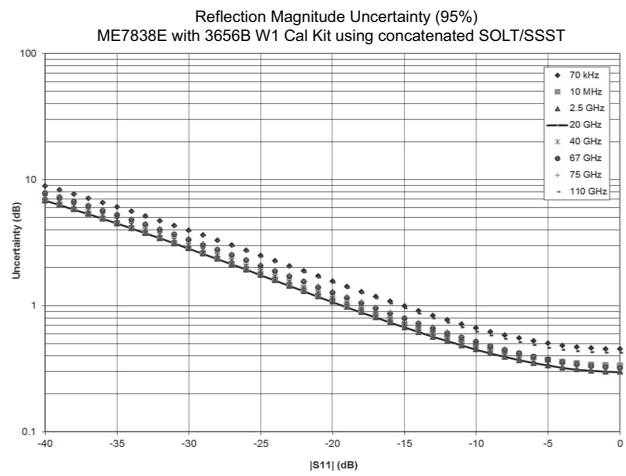

**Corrected System Performance and Uncertainties – SOLT/SSST with .s1p Standards Definitions**

With 12-term concatenated SOLT and Triple Offset Short Calibration (SSST), using the 3656B-3 W1 Calibration Kit. Typical values are in parentheses. Load match is limited by residual directivity. Cable flexure and drift effects are not included.

Frequency (GHz)	Directivity (dB)	Source Match (dB)	Load Match (dB)	Reflection Tracking (dB)	Transmission Tracking (dB)
70 to 10MHz	43 (50)	43 (50)	40 (43)	± 0.1	± 0.1
0.01 to 2.5	43 (50)	43 (50)	40 (43)	± 0.05	± 0.03
2.5 to 20	43 (50)	43 (50)	40 (43)	± 0.05	± 0.05
20 to 67	42 (47)	42 (47)	39 (42)	± 0.05	± 0.07
67 to 95	40 (43)	41 (45)	37 (40)	± 0.05	± 0.07
95 to 110	38 (41)	40 (43)	35 (38)	± 0.05	± 0.07

**Measurement Uncertainties – SOLT/SSST with .s1p Standards Definitions**

The graphs give measurement uncertainties after the above calibration. The errors are worst case contribution of residual directivity, load and source match, frequency response and isolation, network analyzer dynamic accuracy, and connector repeatability while noise effects are added on an RSS basis. 10 Hz IF Bandwidth is used. For transmission uncertainties, it is assumed that  $S_{11} = S_{22} = 0$ . For reflection uncertainties, it is assumed that  $S_{21} = S_{12} = 0$ . For other conditions, please use our free Exact Uncertainty calculator software, downloadable from the Anritsu web site at [www.anritsu.com](http://www.anritsu.com).

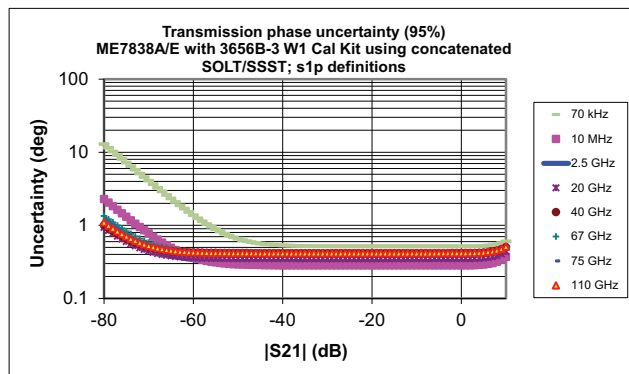
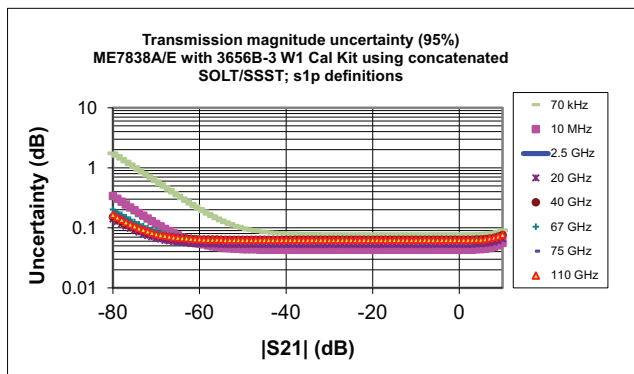
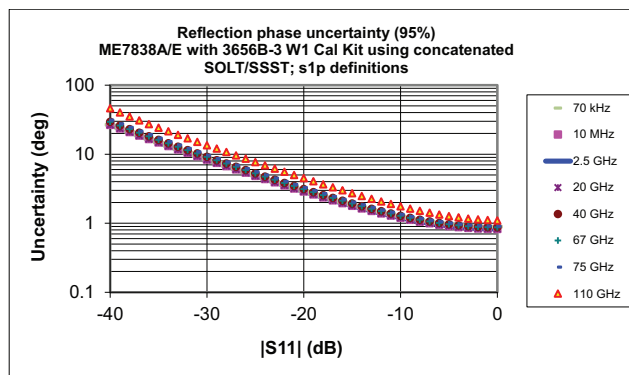
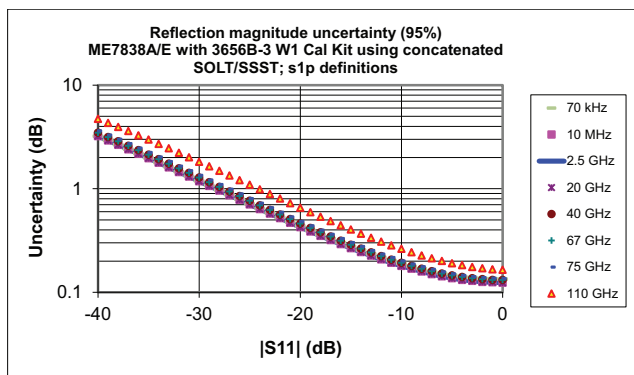



**Corrected System Performance and Uncertainties – LRL/LRM**

With 12 term LRL/LRM calibration using on-wafer substrate standards. Typical. Based on a typical vendor supplied impedance standard substrate.

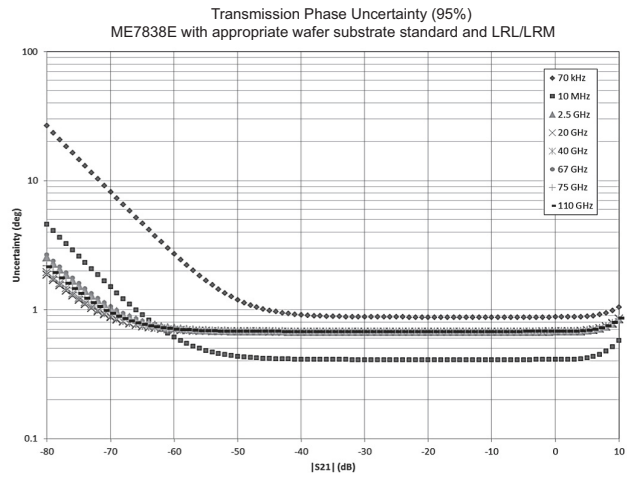
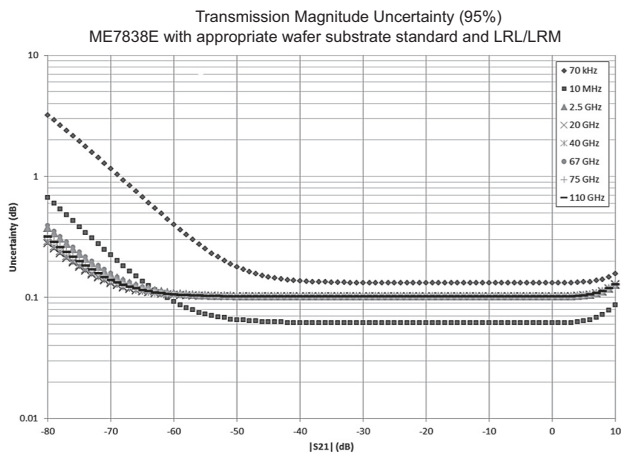
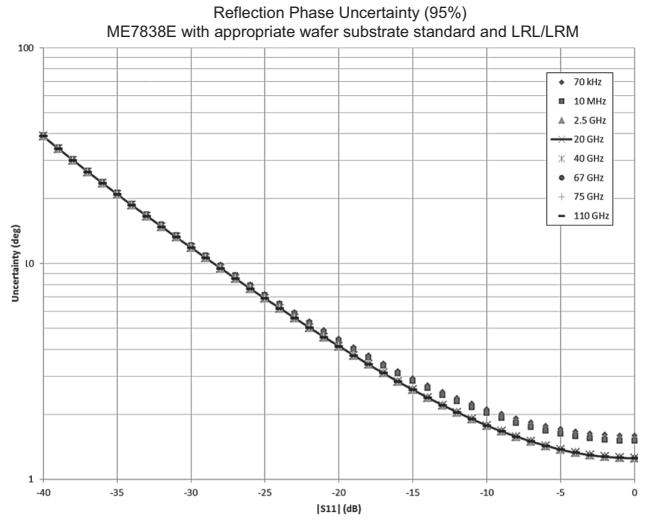
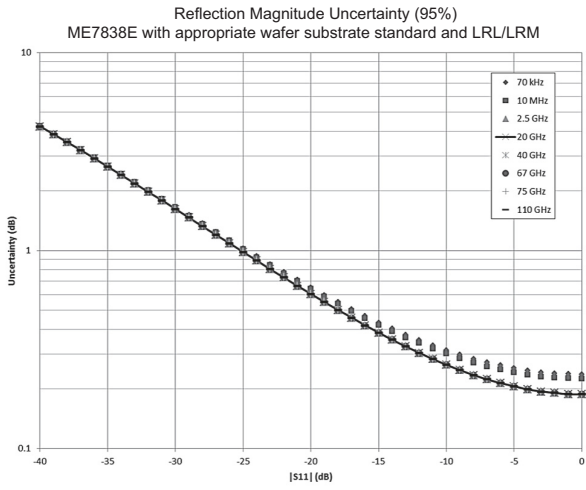

**Measurement Time**

Measurement times include sweep time, retrace time, and band-switching time. Typical.

**Measurement Time (ms)**

Full Band, 70 kHz to 110 GHz, Display ON, and ALC ON.

Calibration	IFBW	Measurement Time (ms) <sup>a</sup>			
		401 Points	1,601 Points	10,001 Points	25,000 Points
1-port calibration	1 MHz	80	100	350	700
	30 kHz	90	160	600	1500
	10 kHz	110	240	1100	2600
	1 kHz	470	1600	10,000	25,000
	10 Hz	47,000	160,000	1,000,000	2,500,000
2-port calibration	1 MHz	160	200	700	1400
	30 kHz	180	320	1200	3000
	10 kHz	220	480	2200	5200
	1 kHz	940	3200	20,000	50,000
	10 Hz	94,000	320,000	2,000,000	5,000,000

a. Measurement times are for the ME7838E Broadband VNA System

**Measurement Time (ms) vs. System Dynamic Range (dB)**

Full Band, Display ON, and ALC ON.

Calibration	401 Points Measurement Time	Achieved System Dynamic Range (Opt 062 at 54 GHz)	IFBW and Averaging Used
Uncorrected or 1-port calibration	110	77	10 kHz/no avg
	470	87	1 kHz/no avg
2-port calibration	220	77	10 kHz/no avg
	940	87	1 kHz/no avg

**Block Diagram – ME7838E Broadband VNA System**

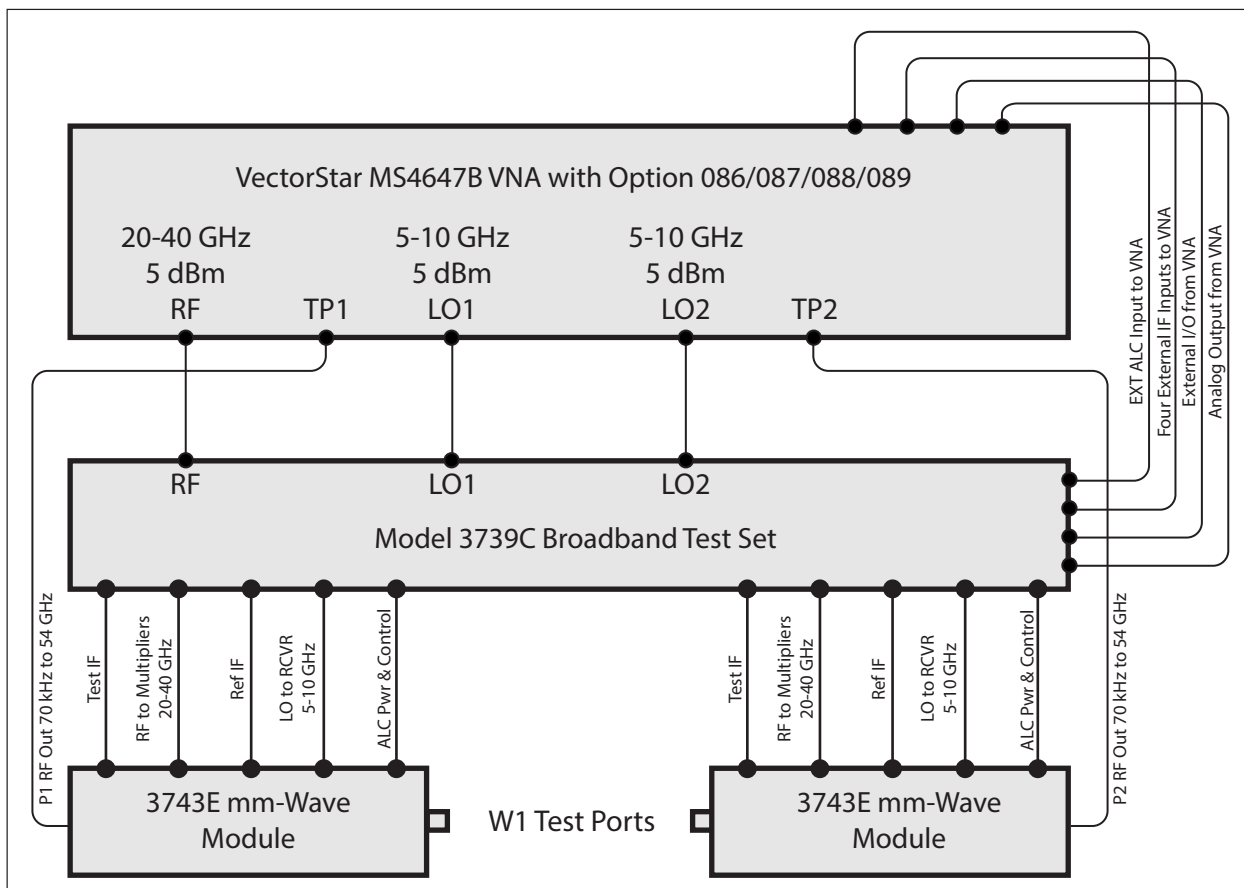

Broadband Configuration Block Diagram

**SC8215 and SC7287 Kelvin Bias Tees**

Provides Sense and Force SMC connections close to the mm-Wave module to minimize the IR drops associated with the impedances between the bias tee and the DUT.

Part Number	Description	Voltage	Current
SC8215	The SC8215 is a V-connectorized bias tee usable with the mm-wave modules in the ME7838E for system frequencies of 70 kHz to 110 GHz. Stand-alone, it is usable to 70 GHz.	Max Voltage: 16 VDC	Max Current: 100 mA
SC7287	The SC7287 is a V-connectorized bias tee usable with the mm-wave modules in the ME7838E for system frequencies of 100 MHz to 110 GHz. Stand-alone, it is usable to 70 GHz.	Max Voltage: 50 VDC	Max Current: 500 mA
Tri-Axial Output SMU	For applications requiring Source Measure Units (SMU) with tri-axial outputs, a tri-axial (male) to SMC (male) cable is available, with the inner-shield isolated from ground at the bias tee SMC end, to float at the SMU guard potential. Check the accessories list for ordering information <a href="#">on page 36</a> .		

**Broadband Measurement Examples**

The following figures are measurement examples of typical ME7838E Broadband system performance.

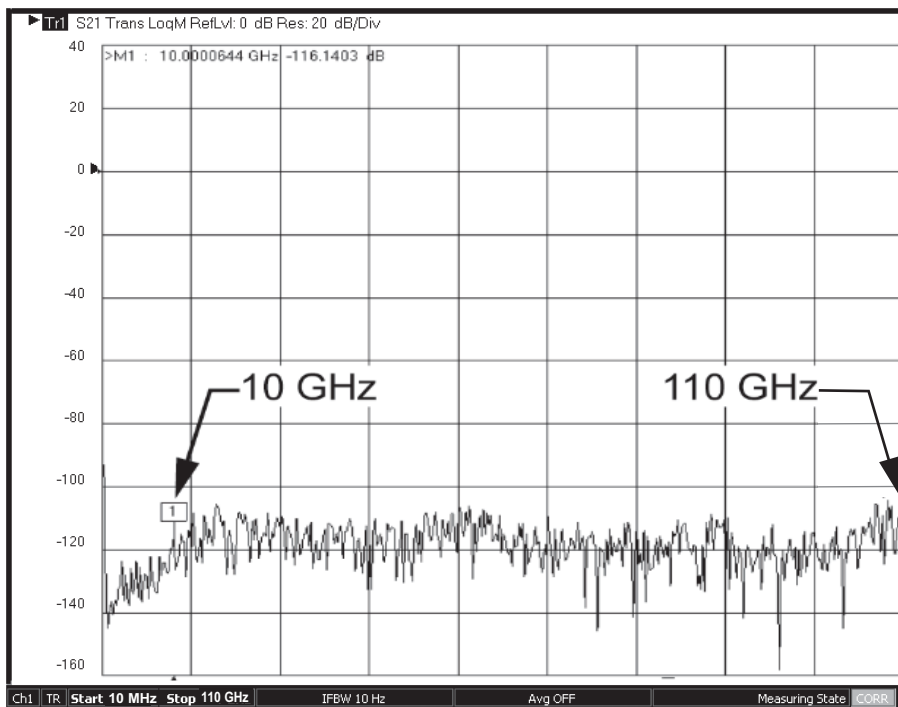

Typical dynamic range of ME7838E system at the W1 1 mm coaxial test port from 70 kHz to 110 GHz.

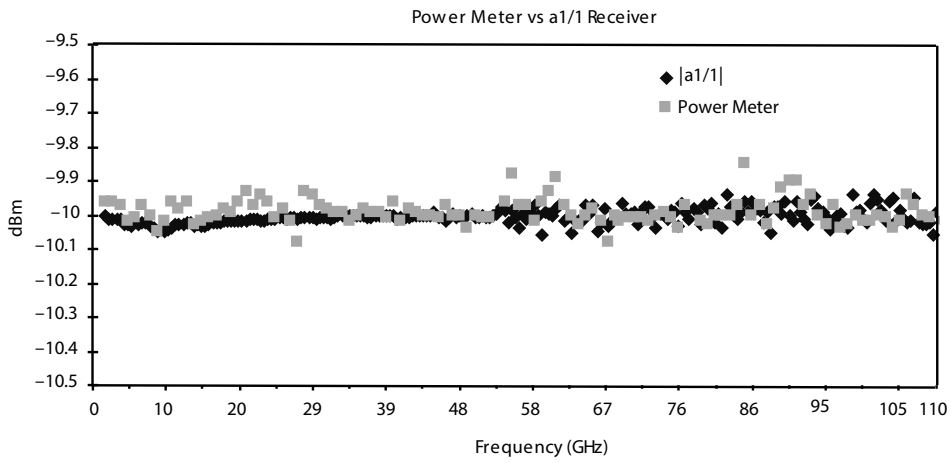

An example of typical power measurement agreement: power sensor vs. ME7838E a1 reference receiver.

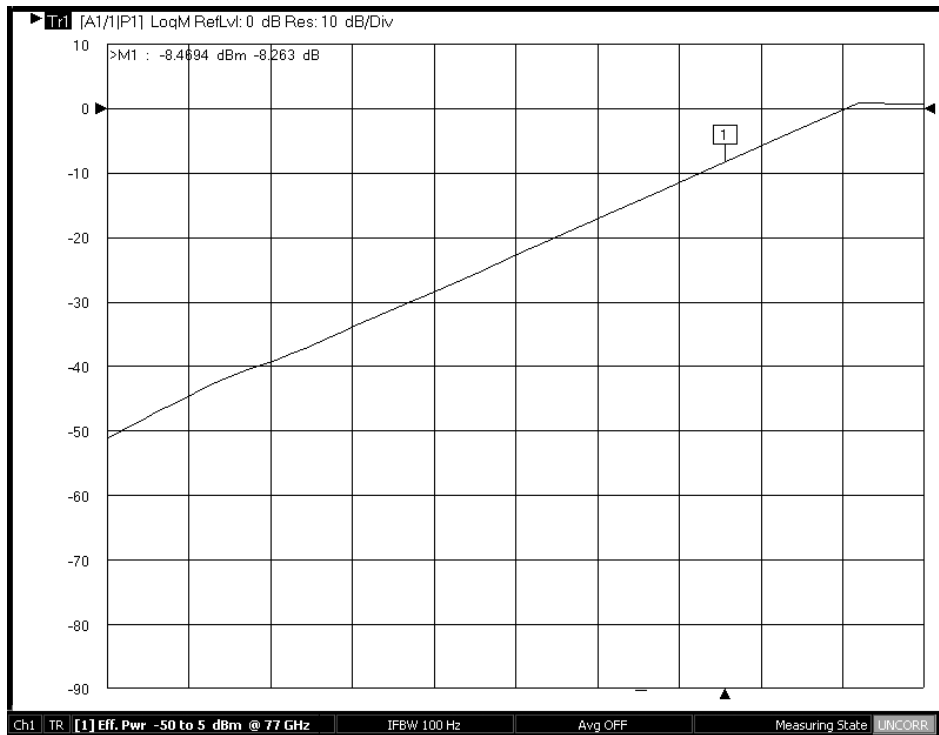

Typical power sweep range at 77 GHz. By using detection and power control inside the 3743E millimeter-wave module; improved accuracy, linearity and range can be achieved.

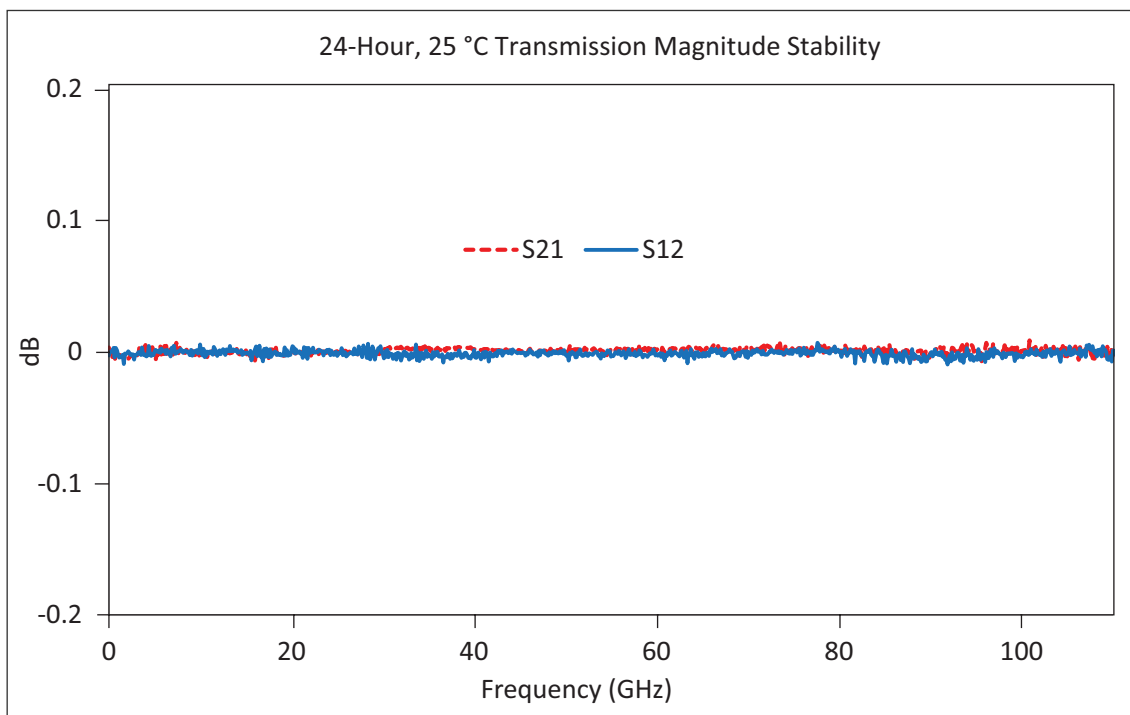

Typical 24-Hour Transmission Magnitude Stability

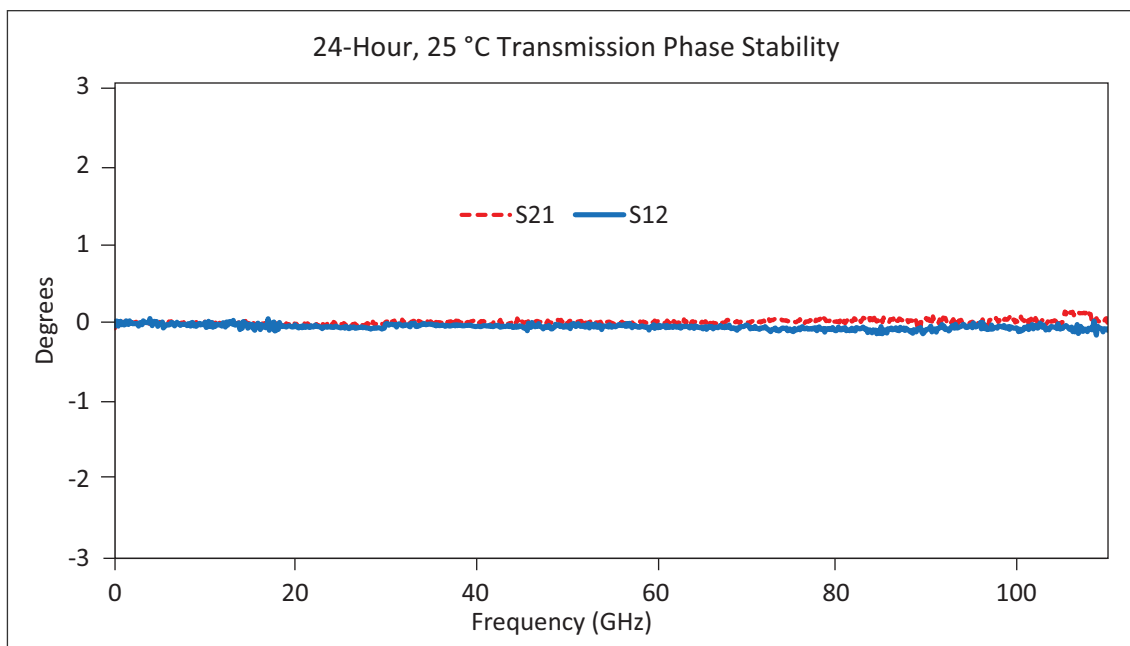

Typical 24-Hour Transmission Phase Stability

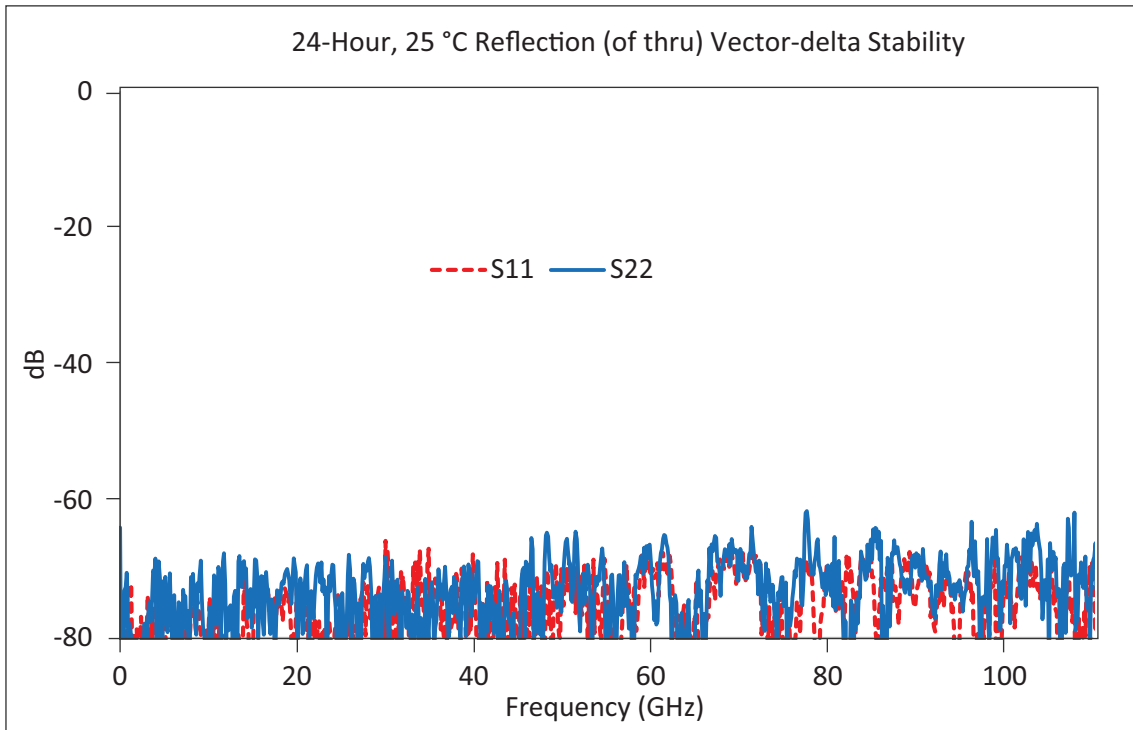

Typical 24-Hour Thru Line Match Vector-delta Stability

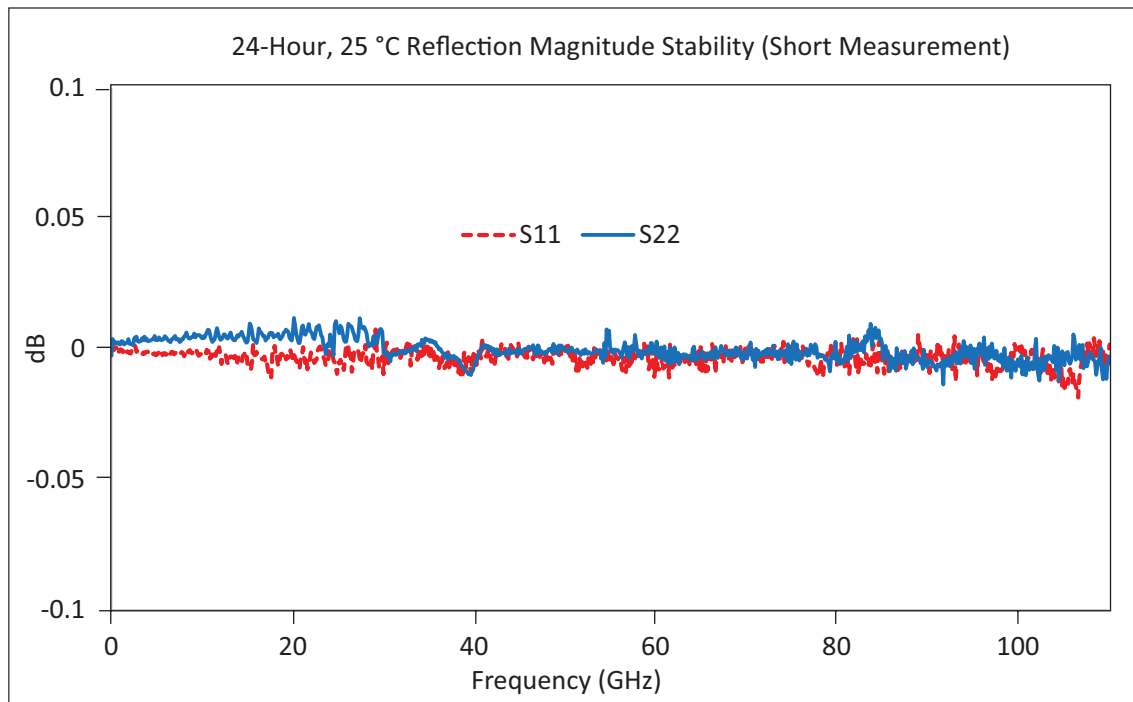

Typical 24-Hour Reflection Magnitude Stability

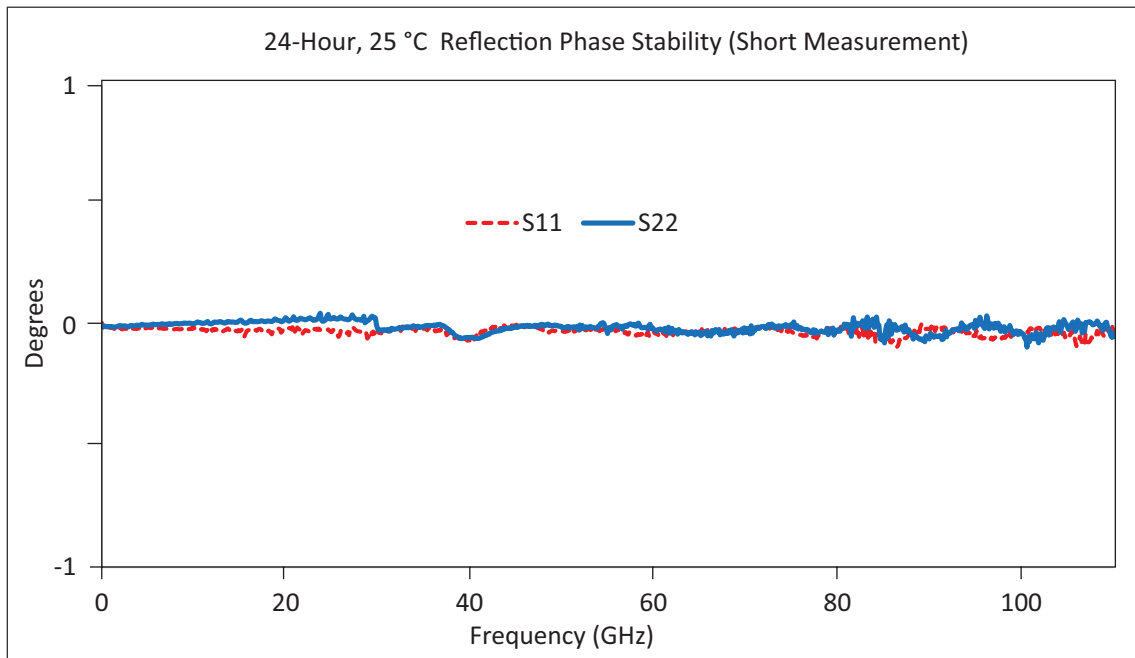

Typical 24-Hour Reflection Phase Stability

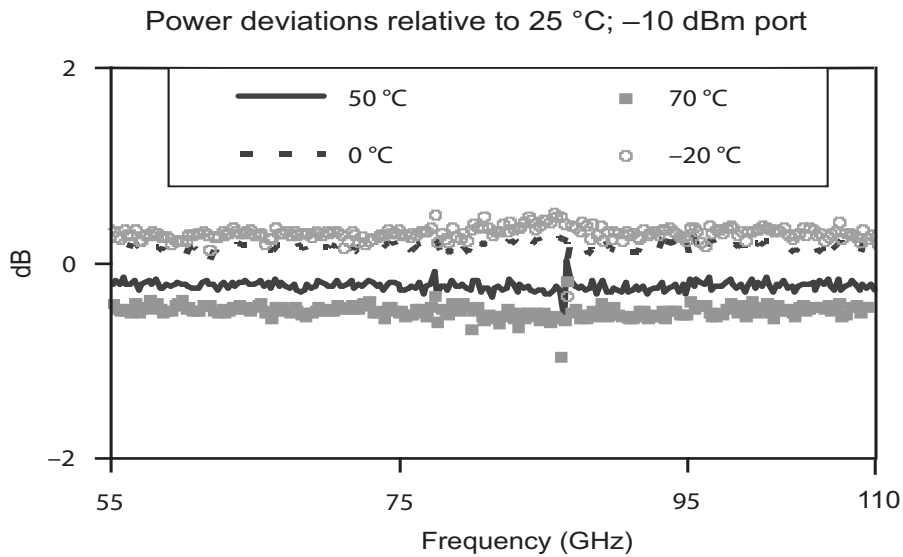

Typical power deviation with respect to wide temperature variation

Waveguide Band Configuration

**ME7838E Millimeter-Wave VNA, Waveguide Bands**

Three configurations are available for waveguide band operation for E and W bands when using the ME7838E system.

- 3743E Module First, the Anritsu 3743E Broadband Millimeter-Wave (mm-Wave) module can be adapted to waveguide measurements using waveguide adapters.
- mm-Wave Modules Second, the Anritsu 3744E-EE or 3744E-EW millimeter-wave module can be used. These version modules operate in the extended E and W waveguide bands and are operational using the MS4644B, or MS4647B VectorStar (with Options 86/87/88/89 and Option 7) and the 3739C broadband/millimeter-wave test set.
- E and W Band mm-Wave Modules The third configuration is to use external E and W band millimeter-wave modules with any model VectorStar (with Options 86/87/88/89 and Option 7) and the 3739C test set. The ME7838E system may also be configured for the above W band mm wave operation. With the addition of VDI modules, operation up to 1.1 THz can be achieved.

**E and W Band Operation Using the 3743E, 3744E-EE, or 3744E-EW mm-Wave Module**



3743E Millimeter-Wave Modules

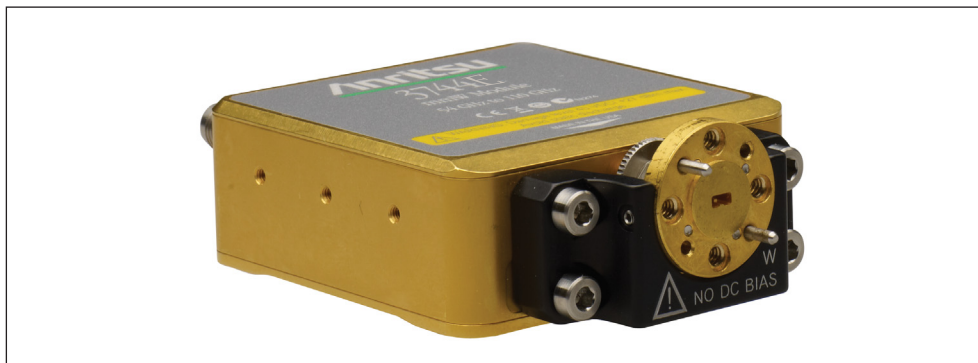

3744E-EE/3744E-EW Millimeter-Wave Module with Waveguide Adapter

The 3743E Broadband mm-Wave module can be adapted to a waveguide band output by adding an available waveguide band adapter and mounting flange. VectorStar menus automatically configure the system frequencies incorporating the 3743E module for banded operation. Using the 3743E modules provides the opportunity to sweep frequencies for broadband applications and quickly convert to waveguide configurations for banded measurements. The advantages of small compact modules with excellent RF performance and power range control can therefore be realized in both broadband and waveguide configurations when using the 3743E mm-Wave module. For systems where only waveguide band operation is required, the 3744E-EE or 3744E-EW mm-Wave module can be used.

The 3744E-EE or 3744E-EW mm-Wave module operates from 54 GHz to 110 GHz. The band supported is determined by the waveguide adapter connected to the 1 mm test port output of the 3744E-EE/EW module:

- 3744E-EE Configures the module for Extended E Band
- 3744E-EW Configures for Extended W Band

The RF input port of the 3744E-EE or 3744E-EW module is restricted below 54 GHz, however, the RF input port retains a DC connection to the 1 mm test port. Thus, the waveguide adapter can be removed for on-wafer applications from 54 GHz to 110 GHz operation and the on-wafer DUT can be biased through the RF input port.

Band	Frequency Range	Waveguide Flange	Transmission/Reflection Module
Ext-E	56 to 94 GHz <sup>a</sup>	WR-12	3744E-EE
Ext-W	65 to 110 GHz	WR-10	3744E-EW

a. Operational to 95 GHz.



Waveguide Band Specifications

**Port Power, Noise Floor, Dynamic Range – 3744E-EE/3744E-EW mm-Wave Modules**

System dynamic range is defined as the ratio of the source power to the noise floor. Maximum Receiver Power is defined as the 0.2 dB compression point of the receiver at the waveguide port. Receiver dynamic range is defined as the ratio of maximum receive power to the noise floor. Noise Floor measurements are RMS, are made with no average in a 10 Hz IF bandwidth, and include an isolation calibration. All figures are typical.

**3744E-EE Extended-E Band (WR-12) Waveguide**

Frequency Range (GHz)	Source Power (dBm)	Max. Receive Power (0.2 dB comp. pt.) (dBm)	Noise Floor (dBm)	System Dynamic Range (dB)	Receiver Dynamic Range (dB)
56 to 60	-2	11	-111	109	122
> 60 to 65	0	11	-106	106	117
> 65 to 80	-3	11	-109	106	120
> 80 to 85	-4	11	-112	108	123
> 85 to 90	-4	11	-110	106	121
> 90 to 94 <sup>a</sup>	0	12	-105	105	117

a. Operational to 95 GHz.

**3744E-EW Extended-W Band (WR-10) Waveguide**

Frequency Range (GHz)	Source Power (dBm)	Max. Receive Power (0.2 dB comp. pt.) (dBm)	Noise Floor (dBm)	System Dynamic Range (dB)	Receiver Dynamic Range (dB)
65 to 67	0	11	-106	106	117
> 67 to 80	-3	11	-109	106	120
> 80 to 85	-4	11	-112	108	123
> 85 to 90	-4	11	-110	106	121
> 90 to 100	0	12	-105	105	117
> 100 to 110	-5	12	-110	105	122

**Power Range, Accuracy, Linearity, and Resolution**

Accuracy is defined at -10 dBm or max rated power, whichever is lower. Linearity is defined as the incremental error between the accuracy test power level and 5 dB below. Typical.

Frequency Range (GHz)	Range (dBm)		Accuracy (dB)	Linearity (dB)	Resolution (dB)
	ME7838E	ME7838E Option 62			
54 to 60	-55 to -2	-55 to -2	± 2.0	± 1.5	0.01
> 60 to 65	-55 to 0	-55 to 0	± 2.0	± 1.5	0.01
> 65 to 80	-55 to -3	-55 to -3	± 2.0	± 1.5	0.01
> 80 to 85	-55 to -4	-55 to -4	± 2.0	± 1.5	0.01
> 85 to 90	-55 to -4	-55 to -4	± 2.0	± 1.5	0.01
> 90 to 100	-55 to 0	-55 to 0	± 3.0	± 2.0	0.01
> 100 to 110	-50 to -5	-50 to -5	± 3.0	± 2.0	0.01

Alternatively, the V, E and W bands can be supported using external millimeter-wave modules such as the 3740/41A series modules available from Anritsu. For further description and specifications, please refer to the VectorStar ME7828A Technical Data Sheet 11410-00452 available at [www.anritsu.com](http://www.anritsu.com).

**Corrected System Performance/Uncertainties - 3744E-EE/3744E-EW mm-Wave Modules**

With 12-term Offset, Short, Sliding-Load, or LRL calibrations, using high precision waveguide sections and standards from the appropriate calibration kit.

**3744E-EE Extended-E Band (WR-12) Waveguide - 56 GHz to 94 GHz**

Calibration Type	Directivity (dB)	Source Match (dB)	Load Match (dB)	Reflection Tracking (dB)	Transmission Tracking (dB)
Offset Short	> 44	> 33	> 44	± 0.080	± 0.100
LRL	> 44	> 43	> 44	± 0.006	± 0.006

**3744E-EW Extended-W Band (WR-10) Waveguide - 65 GHz to 110 GHz**

Calibration Type	Directivity (dB)	Source Match (dB)	Load Match (dB)	Reflection Tracking (dB)	Transmission Tracking (dB)
Offset Short	> 40	> 30	> 46	± 0.080	± 0.100
LRL	> 40	> 40	> 46	± 0.006	± 0.006

**Measurement Uncertainties - Extended-E Band - SSLT**

The graphs give measurement uncertainties after the above calibration. The errors are worst case contribution of residual directivity, load and source match, frequency response and isolation, network analyzer dynamic accuracy, and connector repeatability. 10 Hz IF Bandwidth is used. For transmission uncertainties, it is assumed that  $S_{11} = S_{22} = 0$ . For reflection uncertainties, it is assumed that  $S_{21} = S_{12} = 0$ . All calibrations and measurements were performed at default port power. For other conditions, please use our free Exact Uncertainty Calculator software, available for download from the Anritsu web site at [www.anritsu.com](http://www.anritsu.com). The results below are typical.

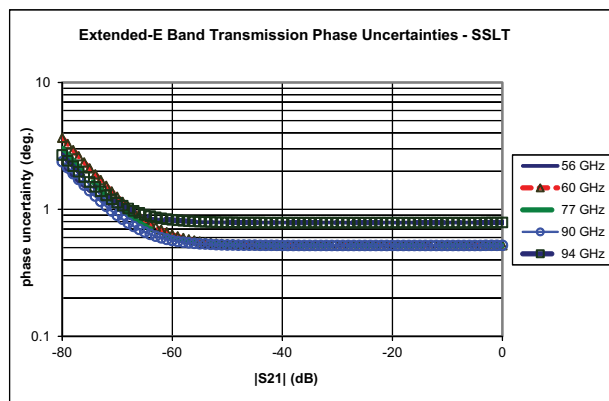
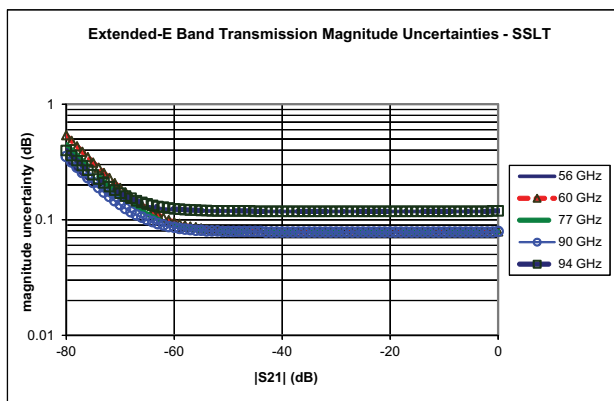
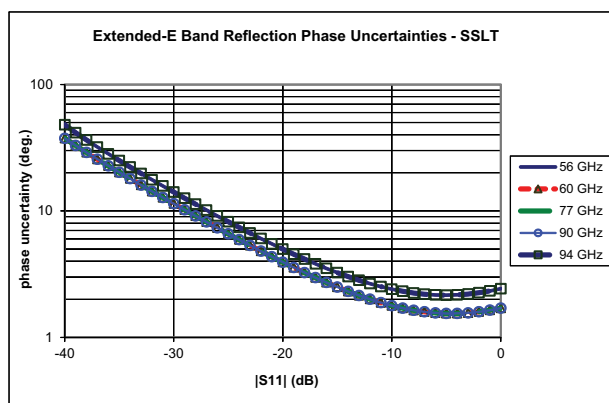
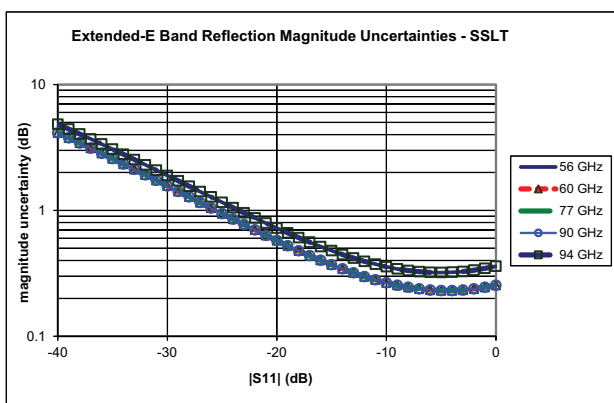

**Measurement Uncertainties – Extended-E Band – LRL**

The graphs give measurement uncertainties after the above calibration. The errors are worst case contribution of residual directivity, load and source match, frequency response and isolation, network analyzer dynamic accuracy, and connector repeatability. 10 Hz IF Bandwidth is used. For transmission uncertainties, it is assumed that  $S_{11}=S_{22}=0$ . For reflection uncertainties, it is assumed that  $S_{21}=S_{12}=0$ . All calibrations and measurements were performed at default port power. For other conditions, please use our free Exact Uncertainty Calculator software, available for download from the Anritsu web site at [www.anritsu.com](http://www.anritsu.com). The results below are typical.

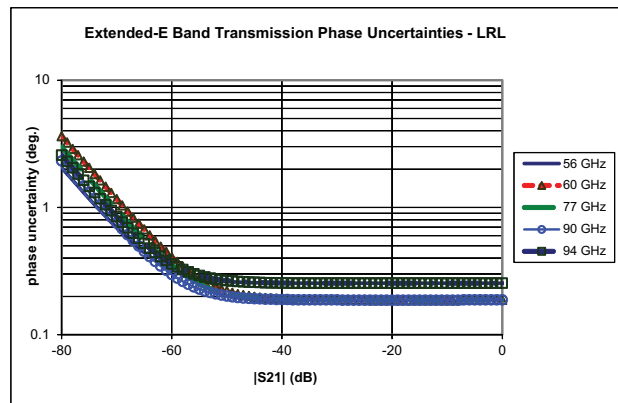
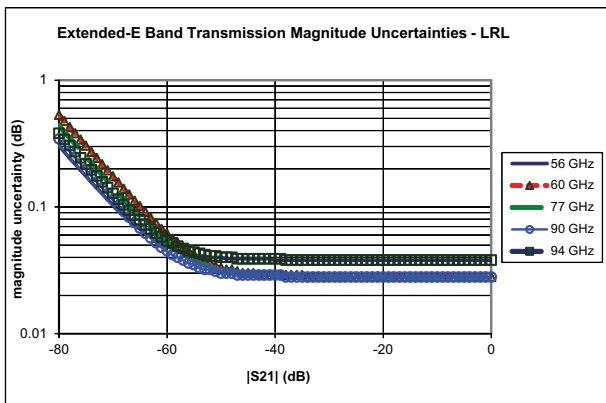
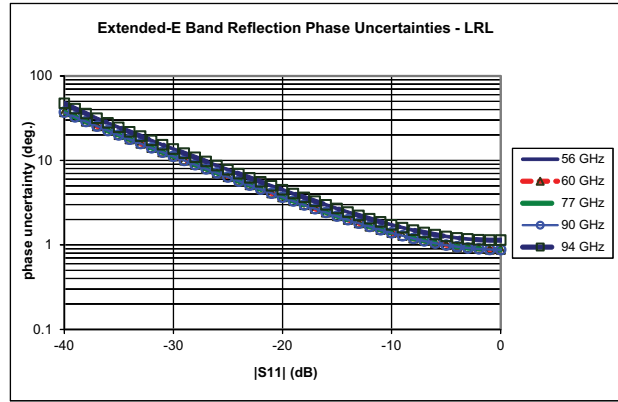
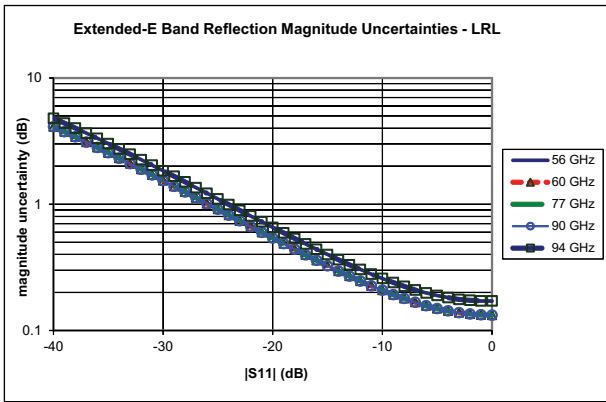

**Measurement Uncertainties – Extended-W Band – SSLT**

The graphs give measurement uncertainties after the above calibration. The errors are worst case contribution of residual directivity, load and source match, frequency response and isolation, network analyzer dynamic accuracy, and connector repeatability. 10 Hz IF Bandwidth is used. For transmission uncertainties, it is assumed that  $S_{11} = S_{22} = 0$ . For reflection uncertainties, it is assumed that  $S_{21} = S_{12} = 0$ . All calibrations and measurements were performed at default port power. For other conditions, please use our free Exact Uncertainty Calculator software, available for download from the Anritsu website at [www.anritsu.com](http://www.anritsu.com). The results below are typical.

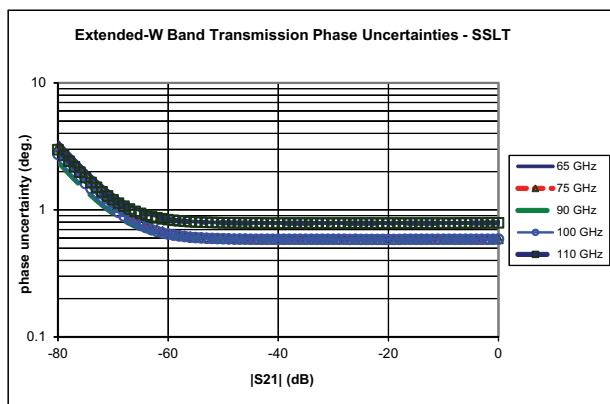
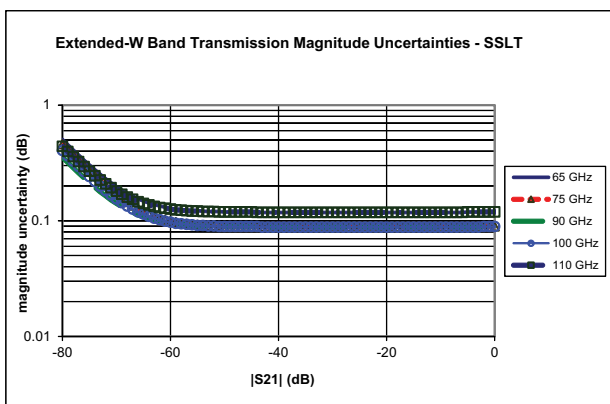
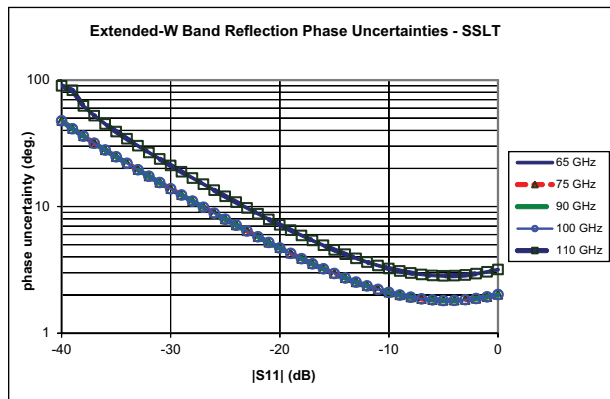
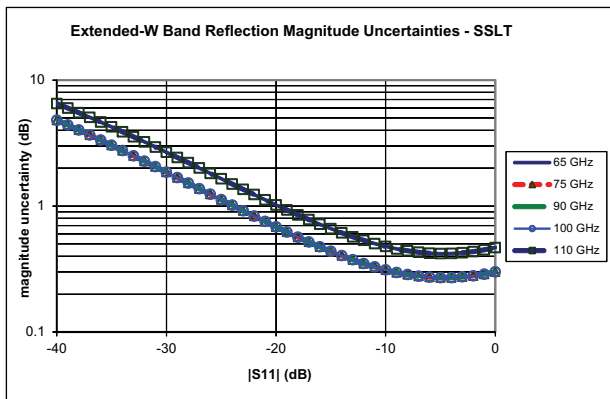

**Measurement Uncertainties – Extended-W Band – LRL**

The graphs give measurement uncertainties after the above calibration. The errors are worst case contribution of residual directivity, load and source match, frequency response and isolation, network analyzer dynamic accuracy, and connector repeatability. 10 Hz IF Bandwidth is used. For transmission uncertainties, it is assumed that  $S_{11}=S_{22}=0$ . For reflection uncertainties, it is assumed that  $S_{21}=S_{12}=0$ . All calibrations and measurements were performed at default port power. For other conditions, please use our free Exact Uncertainty Calculator software, available for download from the Anritsu website at [www.anritsu.com](http://www.anritsu.com). The results below are typical.

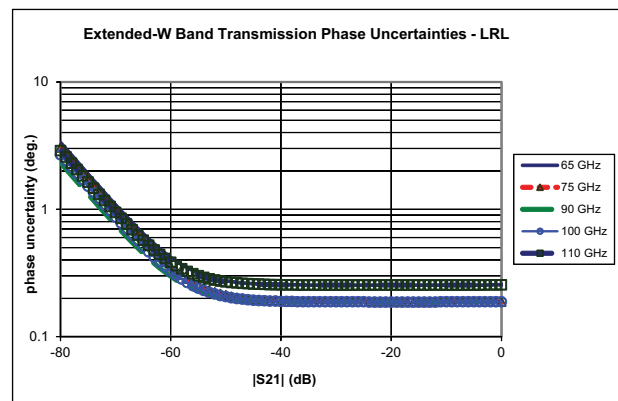
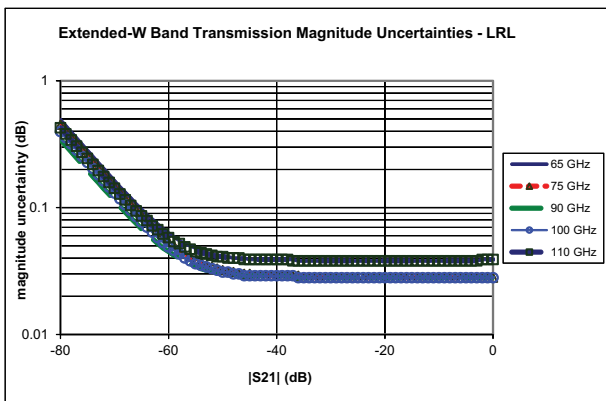
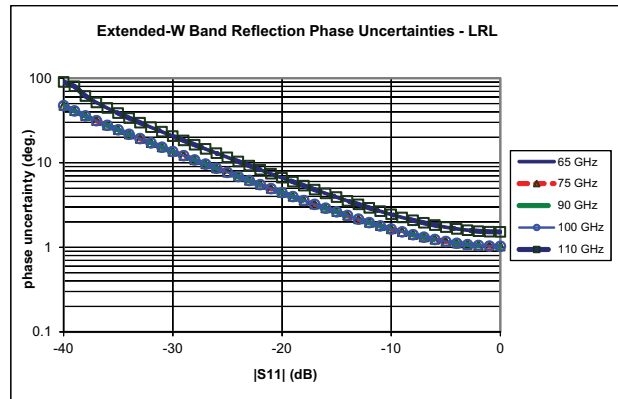
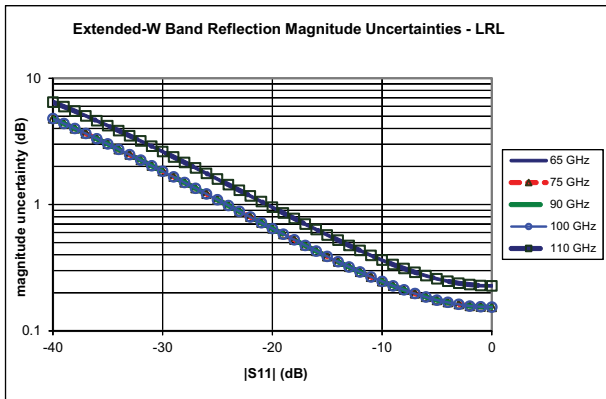

## Millimeter-Wave Noise Figure Measurements with Option 41/48 and 3744E-Rx

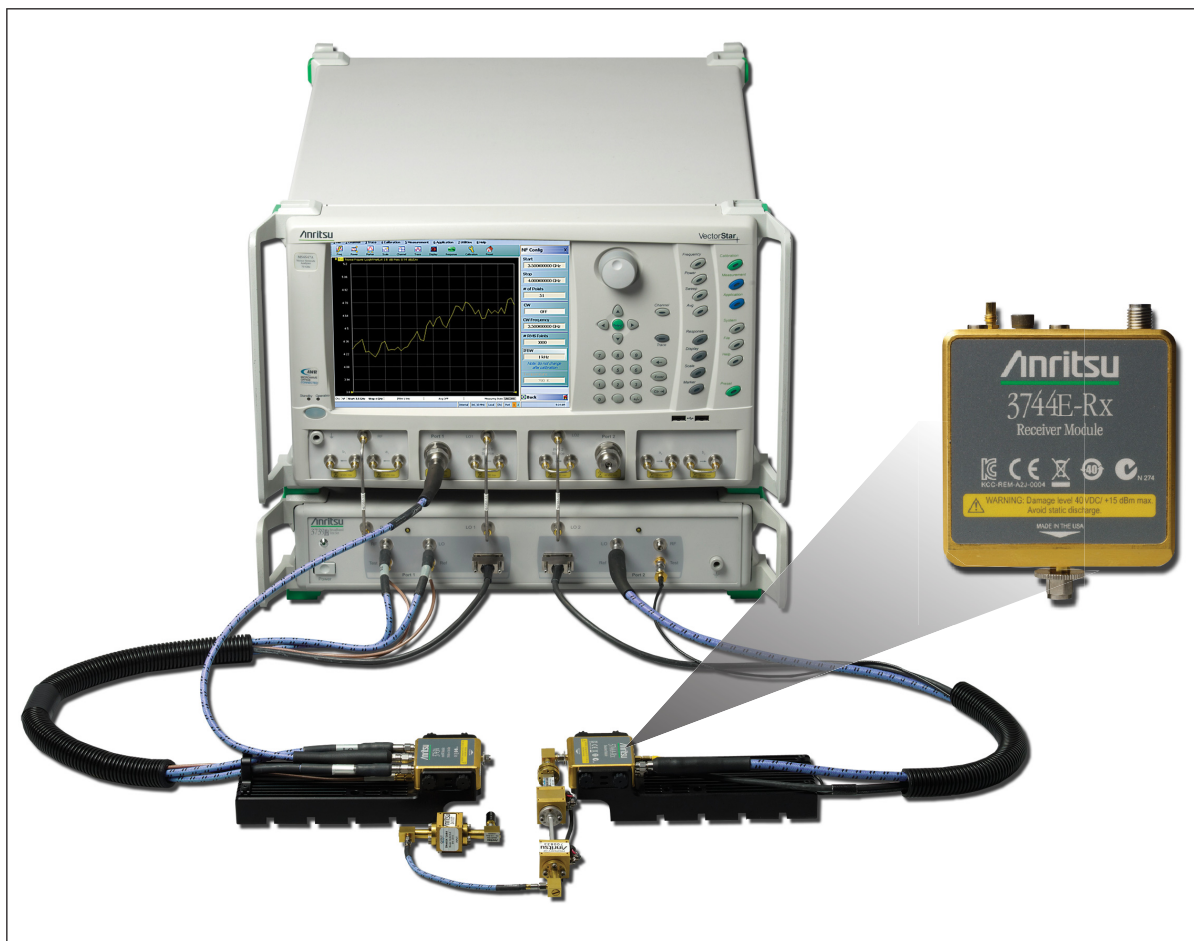

ME7838E with 3744E-Rx Receiver Module

The 3744E-Rx receiver module can be used with Option 41, Noise Figure, and the ME7838E mm-Wave or broadband system to perform mm-Wave noise figure measurements from 30 GHz to 110 GHz. The receiver bypasses the internal couplers (see block diagram on next page), maximizing the noise figure of the receiver for optimum noise figure measurement accuracy. The receiver is derived from the 3743E mm-Wave module and utilizes the same nonlinear transmission line technology for optimum mm-Wave performance. Using the advantages of the 3743E mm-Wave module system architecture provides a unique solution to mm-Wave noise figure measurements previously unavailable.

With Option 48, differential (and common-mode) noise figure measurements are possible in the same wide frequency ranges. In this case, two 3744A-Rx modules (along with needed pre-amplifiers/filters) are used to complete the differential receiver. While usually a 4-port system is used, a 2-port ME7838E can be used for the noise measurements as long as DUT gain information is available.

**Block Diagram – 3744E-Rx Receiver Module**

As with all cold source method noise figure measurements, the output of the DUT is first sent to an external composite receiver for pre-amplification. This ensures that the system noise figure is minimized for optimum measurement accuracy. The Anritsu Noise Figure Uncertainty Calculator (available on the website at [www.anritsu.com](http://www.anritsu.com)) can be used to determine optimum preamplifier gain needed for the desired measurement uncertainty.

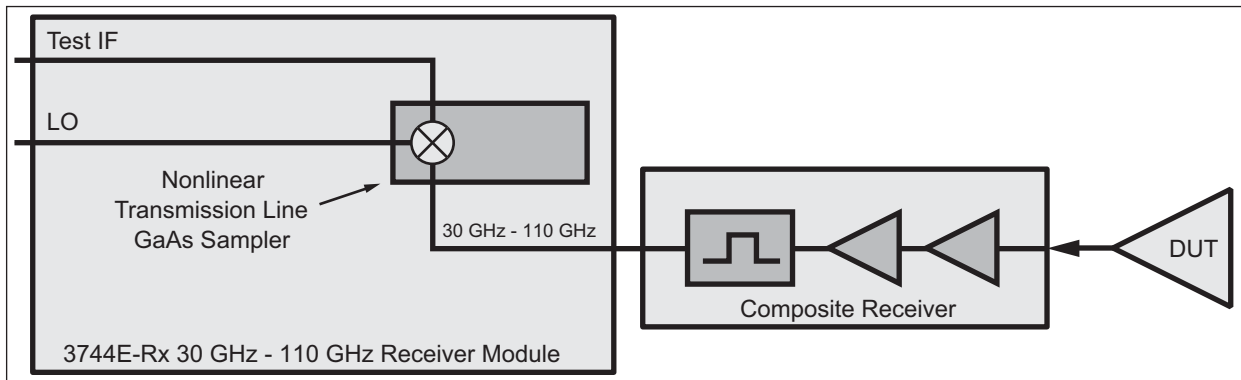

3744E-Rx Block Diagram

(Two composite receivers and two 3744A-Rx modules are used with Option 48 for differential or common-mode noise figure measurements.)

**3744E-Rx Receiver Compression, Noise Floor**

Receiver Compression Point is defined as the port power level beyond which the response may be compressed more than 0.2 dB relative to the normalization level. 10 Hz IF bandwidth is used to remove trace noise effects. All typical.

Noise Floor is relative to the receiver power calibration performed at -10 dBm. Typical.

Frequency Range	Receiver Compression (dBm) <sup>a</sup>	Noise Floor (dBm) <sup>b</sup>
30 to 54 GHz	0	-124
54 to 60 GHz	0	-122
60 to 67 GHz	0	-117
67 to 80 GHz	0	-120
80 to 85 GHz	0	-123
85 to 90 GHz	0	-121
90 to 95 GHz	0	-121
95 to 105 GHz	0	-117
105 to 110 GHz	0	-122

a. At the 3744E-Rx test port.

b. Excludes localized spurious responses and crosstalk.

**Waveguide Bands from 50 GHz to 1.1 THz**

The VectorStar Millimeter-Wave system supports OML or VDI modules starting at 50 GHz. System performance is based on the specific mm-Wave module installed and appropriate cal kit. The mm-Wave modules need to provide IF levels of -15 dBm to -5 dBm when the RF drive is set to maximum in order to deliver specified dynamic range. Contact the vendor web site for additional information.



VDI and OML Millimeter-Wave Modules

**Block Diagram – Millimeter-Wave VNA System**

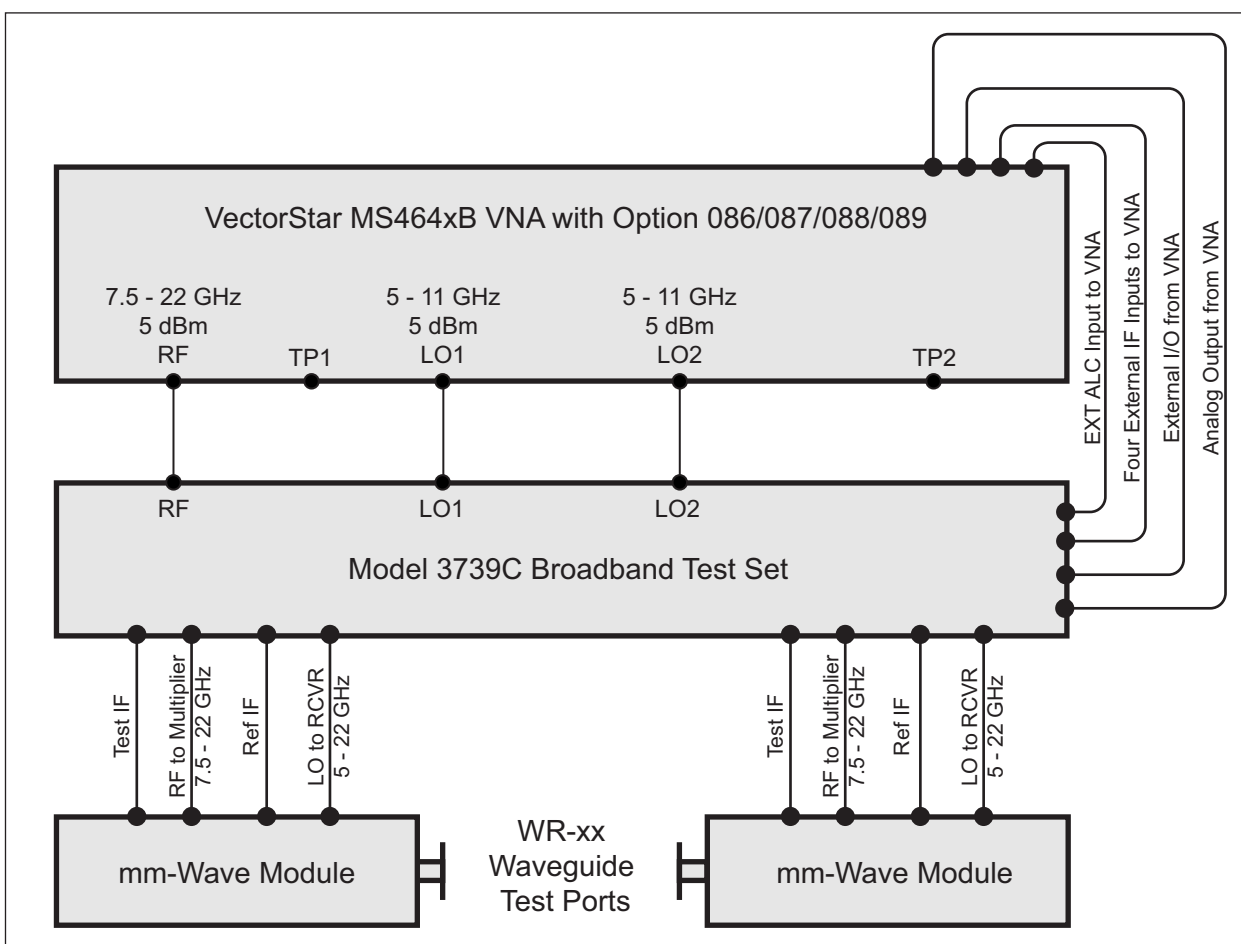

Millimeter-Wave Configuration Block Diagram



**VectorStar ME7838E Millimeter-Wave System with VDI Modules**

This section provides the specifications for the VectorStar MS4640B series microwave Vector Network Analyzers (VNAs) when configured with the Virginia Diodes, Inc. millimeter-wave (mm-Wave) frequency extension modules. The following frequency bands are supported:

Waveguide Band	WR15	WR10	WR8.0	WR6.5	WR5.1	WR4.3	WR3.4	WR2.8	WR2.2	WR1.5	WR1.0 <sup>a</sup>
Frequency (GHz)	50 to 75	75 to 110	90 to 140	110 to 170	140 to 220	170 to 260	220 to 330	260 to 400	330 to 500	500 to 750	750 to 1100

a. Contact Anritsu

**System Configuration with VDI Modules**

The VectorStar Millimeter-Wave system provides control of VDI modules for frequency extension coverage up to 1.1 THz\*. MS4640B series VectorStar VNA may be configured for mm-Wave operation by adding the appropriate control option and test set. System requirements include:

- VectorStar VNA Model MS4642B, MS4644B, or MS4647B  
(**Note:** For 1.1 THz operation the 40 GHz MS4644B or higher model is required.)
- Options MS4640B Option 7, Receiver Offset  
MS4640B Option 86, 87, 88, or 89
- Test Set 3739C Test Set
- Cable SM6537 Interface Cable – Connection between VectorStar and the VDI mm-Wave module is provided with this interface cable.  
Each VDI module is equipped with a dedicated external power supply and DC cable.

**VDI Module Specifications**

- Specifications: Dynamic range (DR) specifications are valid for any MS4640B VectorStar VNA with appropriate options. Directivity specifications are valid when using appropriate VDI calibration kits. These specification results assume a through measurement with two TxRx Heads. All extender heads include a precision Test Port. The specifications here are typical and subject to change.
- Stability: Measured for 1 hour after a 1 hour system warm-up, in a stable environment with ideal cables.
- Dynamic Range: The dynamic range (RBW 10 Hz) is measured by first connecting two TxRx heads together and normalizing the un-calibrated S21 and S12. The heads are then disconnected and terminated with a waveguide short. The rms of the measured S21 & S12 give the system dynamic range.
- Test Port Power: Test Port Power is typical. Reduced power is possible at band edges.

Waveguide Band Frequency Coverage (GHz)	VDI Extenders-Summary of Specifications											
	WR15 50-75	WR12 60-90	WR10 75-110	WR8.0 90-140	WR6.5 110-170	WR5.1 140-220	WR4.3 170-260	WR3.4 220-330	WR2.8 260-400	WR2.2 330-500	WR1.5 500-750	WR1.0 750-1100
Dynamic Range BW = 10 Hz, dB, (Typical)	120	120	120	120	120	120	115	115	100	110	100	65
Dynamic Range BW = 10 Hz, dB, minimum	110	110	110	110	110	110	110	105	80	100	80	45
Magnitude Stability (± dB)	0.15	0.15	0.15	0.15	0.25	0.25	0.3	0.3	0.5	0.5	0.4	0.5
Phase Stability (± deg.)	2	2	2	2	4	4	4	6	6	6	4	6
Test Port Power (dBm Typical)	13	13	18	6	13	6	-2	1	-10	-3	-25	-30
Test Port Input Limit <sup>a</sup> (dBm, Saturation/Damage)	30	30	30	30	30	30	28	26	16	10	-3	-3
Directivity (dB)	30	30	30	30	30	30	30	30	30	30	30	30

a. Test Port Input Limits are shown for standard test port power models only.

**VDI Module Head Configurations**

- TxRx Transmitter with two receivers (reference and measurement), and two couplers. Two TxRx heads are required for full two-port measurements.
- TxRef Transmitter with reference receiver and one coupler.
  - Rx Measurement receiver.
  - Tx Transmitter.

**VDI Module Options**

- Micrometer-Drive Variable Attenuator A 0 dB to 30 dB micrometer-drive variable attenuator option is available on TxRx and Tx modules up through WR1.5. If ordered, "-Attn" is added as an option suffix to the module model number. The attenuators reduce TPP and DR by as much as 5dB in the WR3.4 and higher frequency bands and add approximately 2 in to the enclosure.
- Increased Test Port Power Options exist for increasing test port power in some full bands or in partial bands. Consult factory for more information.
- Non-Standard Frequency Bands Non-standard frequency bands or other specific needs are possible. Consult factory for more information.
- Custom Configuration Anritsu/VDI will work with customers to reconfigure any extender to meet specific needs.

ME7838E Measurement Examples Using VDI Millimeter-Wave Modules

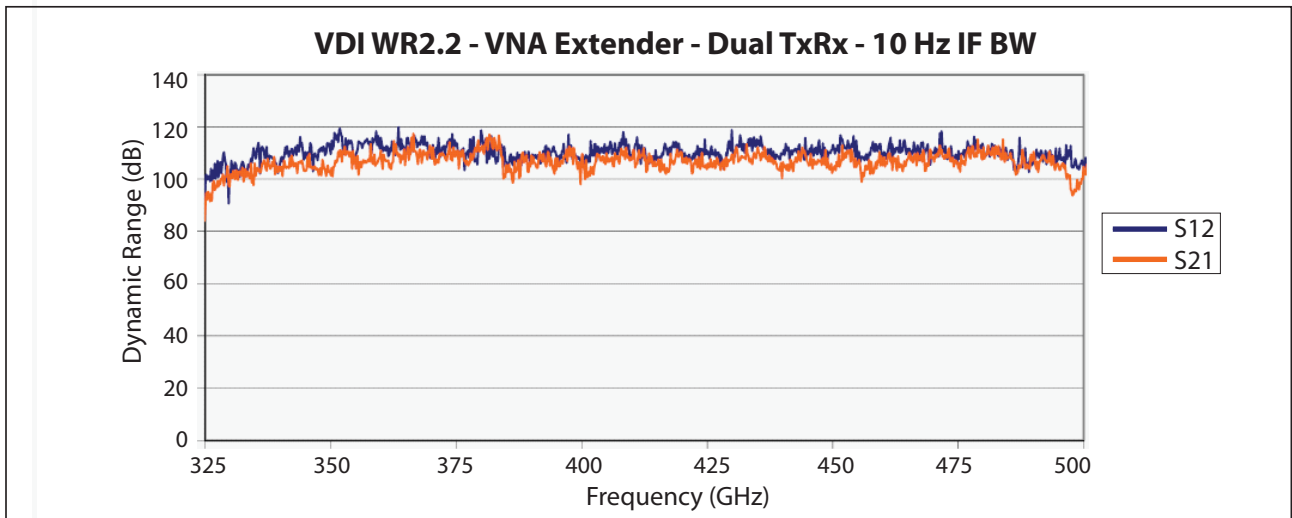

Typical Dynamic Range Plot of VDI WR2.2 Module - 10 Hz IFBW

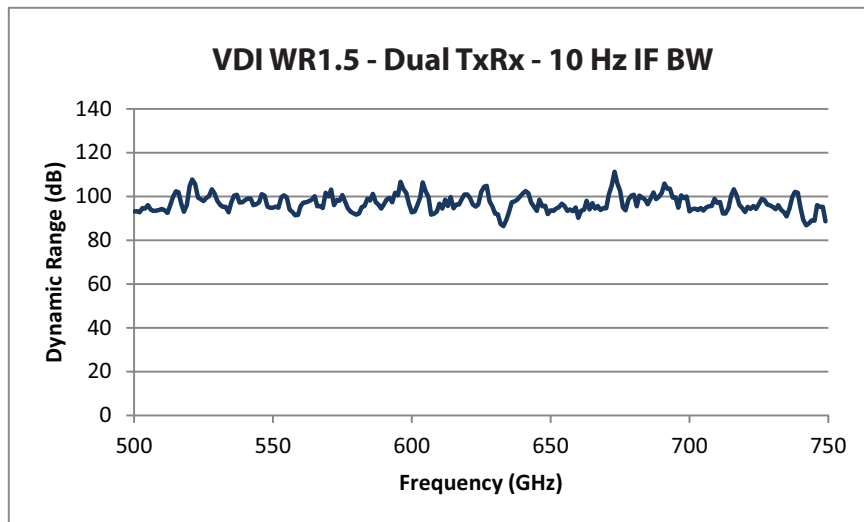

Typical Dynamic Range Plot of VDI WR1.5 Dual TxRx - 10 Hz IFBW

ME7838E 400 GHz Power Sweep with VDI WR2.2 TxRx Module

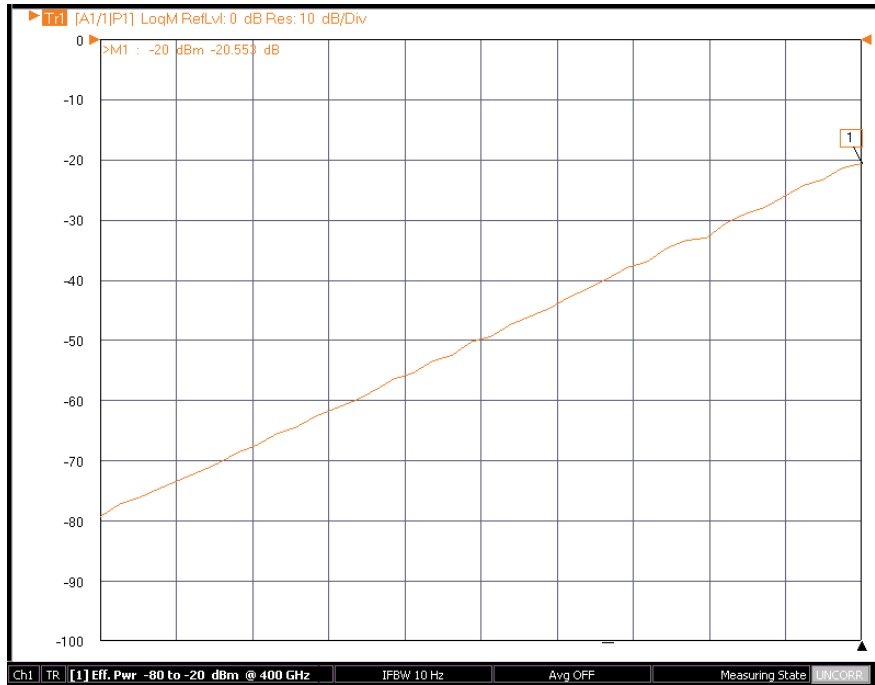

Typical real-time power sweep of VDI WR2.2 module using system power level control and no mechanical attenuators.

**VectorStar ME7838E Millimeter-Wave System with OML Modules**

This section provides specifications for the VectorStar MS4640B series microwave Vector Network Analyzers (VNAs) when configured with the OML millimeter-wave frequency extension modules.

Description	Each OML module must be equipped with a dedicated external power supply and DC cable. Connection between the VectorStar and the OML mm-Wave module is provided with the supplied interface cable.
System Configuration	The VectorStar Millimeter-Wave system provides control of OML modules for frequency extension coverage up to 325 GHz. The MS4640B series VectorStar VNA may be configured for mm-Wave operation by adding the appropriate control option and test set.
System requirements	MS4642B, MS4644B, or MS4647B Model VectorStar VNA MS4640B Option 7, Receiver Offset MS4640B Option 86, 87, 88, or 89 SM6537 Interface Cable 3739C Test Set
Specifications	Dynamic range specifications are valid for any MS4640B VectorStar VNA with appropriate options. Directivity specifications are valid when using appropriate OML calibration kits.

**OML Millimeter-Wave Extenders Summary Specifications**

OML "T/R" Models <sup>a</sup>	Units	Measurement	V15VNA2-T/R	V12VNA2-T/R	V10VNA2-T/R	V08VNA2-T/R	V06VNA2-T/R	V05VNA2-T/R	V03VNA2-T/R
<b>Output Interface<sup>b</sup> Operating Frequency</b>	GHz	-	WR-15 50 - 75	WR-12 60 - 90	WR-10 75 - 110	WR-08 90 - 140	WR-06 110 - 170	WR-05 140 - 220	WR-03 220 - 325
<b>Test Port Output Power<sup>c</sup></b>	dBm	<b>Minimum Typical</b>	+5 +8	+2 +5	+3 +5	-8 -4	-15 -10	-18 -13	-23
<b>Test Port Input Power at 0.1 dB Compression<sup>d</sup></b>	dBm	<b>Typical</b>	+8	+8	+6	+4	-5	-5	-5
<b>Test Port Match<sup>c</sup></b>	dB	<b>Typical</b>	>17	>17	>17	>17	>15	>15	>9
<b>Residual Source and Load Match</b>	dB	<b>Typical</b>	>35	>35	>35	>35	>35	>35	>33
<b>Test Dynamic Range<sup>e</sup></b>	dB	<b>Minimum Typical</b>	92 >105	92 >105	95 >110	90 >105	80 >95	80 >95	60 >75
<b>Reflection and Transmission Tracking<sup>f</sup></b>	dB Deg	<b>Magnitude Phase</b>	±0.2 ±2	±0.2 ±2	±0.2 ±2	±0.3 ±3	±0.4 ±5	±0.4 ±6	±0.4 ±8
<b>Coupler Directivity<sup>c</sup></b>	dB	<b>Typical</b>	>35	>35	>35	>33	>30	>30	>30
<b>Size<sup>g</sup></b>	in	<b>(L x W x H)</b>	13.0 x 4.3 x 2.7						

a. Specifications are typical and subject to change without notice.  
 b. Test Port Flange Configuration is compatible with MIL-DTL-3922/67D (UG 387/U-M).  
 c. As there are no internationally recognized power standards above 110 GHz, any power data supplied above 110 GHz is traceable only to OML's calorimeter.  
 d. Not Tested.  
 e. Measured at 10 Hz IF bandwidth.  
 f. At +25 °C. Measured for 1 hr after 1 hr warm-up. Based on "perfect" RF and LO test cables not moved after warm-up and calibration. Not tested.  
 g. Height excludes the adjustable rubber feet; length and depth dimensions exclude the output waveguide length.

## Standard Capabilities for All Configurations

For standard capabilities of the VectorStar VNAs, please see the **VectorStar MS4640B Series VNA Technical Data Sheet – 11410-00611**, available at [www.anritsu.com](http://www.anritsu.com).

## Mechanical and Environmental

### MS4640B Vector Network Analyzer

Dimensions without rack mount option.	
Height	267 mm body (6u) 286 mm between feet outer edges
Width	426 mm body 457 mm between feet outer edges 487 mm between front panel handles outer edges
Depth	502 mm body 591 mm between handle and foot outer edges
Weight	< 28 kg (< 60 lbs), Typical weight for a fully-loaded MS4647B VNA

### 3739C Broadband/Millimeter-Wave Test Set

Dimensions without rack mount option.	
Height	89 mm body (2u) 108 mm between feet outer edges
Width	426 mm body 457 mm between feet outer edges 487 mm between front panel handles outer edges
Depth	502 mm body 591 mm between handle and foot outer edges
Weight	5.75 kg

### 3743E Millimeter-Wave Module

Height	21.5 mm
Width	54 mm
Depth	55.3 mm
Weight	0.27 kg

### Environmental – Operating

Conforms to MIL-PRF-28800F (Class 3)	
Temperature Range	0 °C to +50 °C without error codes* * Except for 'unleveled' error messages that may occur at the extreme edges of the temperature range above.
Relative Humidity	5 % to 95 % at +30 °C, Non-condensing
Altitude	4,600 m (15,000 feet)

### Environmental – Non-Operating

Temperature Range	-40 °C to +71 °C
Relative Humidity	0 % to 90 % at +30 °C, Non-condensing
Altitude	4,600 m (15,000 feet)

## Regulatory Compliance

European Union	EMC 2014/30/EU, EN 61326:2013, CISPR 11/EN 55011, IEC/EN 61000-4-2/3/4/5/6/8/11 Low Voltage Directive 2014/35/EU Safety EN 61010-1:2010 RoHS Directive 2011/65/EU applies to instruments with CE marking placed on the market after July 22, 2017.
Australia and New Zealand	RCM AS/NZS 4417:2012
South Korea	KCC-REM-A21-0004

## Warranty

The ME7838E Series VNAs and related accessories offer a 3 year warranty from the date of shipment (excluding OML and VDI modules). Please contact your local service center for additional warranty coverage.

## Calibration and Correction Capabilities

<b>Calibration Methods</b>	Short-Open-Load-Through (SOLT) with Fixed or Sliding Load and supporting .s1p-defined cal kits Offset-Short-Offset-Short-Load-Through (SSLT) with Fixed or Sliding Load Triple-Offset-Short-Through (SSST) Short-Open-Load-Reciprocal (SOLR) or Unknown Through Method (SSLR, SSSR) Line-Reflect-Line (LRL) / Line-Reflect-Match (LRM) – (up to 5 bands supported for multi-line configurations) Advanced-LRM (A-LRM™) for improved on-wafer calibrations mTRL (Multiline TRL) AutoCal Thru Update available Secondary match correction available for improved low insertion loss measurements
<b>Correction Models</b>	2-Port (Forward, Reverse, or both directions) 1-Port ( $S_{11}$ , $S_{22}$ , or both) Transmission Frequency Response (Forward, Reverse, or both directions) Reflection Frequency Response ( $S_{11}$ , $S_{22}$ , or both)
<b>Merged Calibration</b>	Merge multiple calibration methods over bands of frequency points. Note that merge does not need to be used for broadband coaxial (SOLT/R-SSST/R) 1 mm or 0.8 mm calibrations using Anritsu calibration kits. These can be done as one unified calibration.
<b>Coefficients for Calibration Standards</b>	Use the Anritsu calibration kit USB Memory Device to load kit coefficients and characterization files. Enter manual coefficients into user-defined locations. Use complex load models.
<b>Reference Impedance</b>	Modify the reference impedance from 50 $\Omega$ to any impedance greater than 0 $\Omega$ .
<b>Interpolation</b>	Allows interpolation between calibration frequency points. Accuracy will be reduced at non-calibration frequencies and that degradation is dependent on the frequency step size in the initial calibration and the electrical length of the user's setup.
<b>Adapter Removal Calibration</b>	Characterizes and "removes" an adapter that is used during calibration that will not be used for subsequent device measurements; for accurate measurement of non-insertable devices.
<b>Dispersion Compensation</b>	Selectable as Coaxial, other non-dispersive (e.g., for coplanar waveguide), Waveguide, or Microstrip.
<b>Power</b>	
Power Meter Correction	Different power meter calibrations are available to enhance power accuracy at the desired reference plane. The source power will match the target calibration power, as read by the power meter, to within ~0.1 dB for short periods of time (determined by thermal drift of the system and the power meter). The absolute accuracy of the calibrated power will be dependent on the power meter and sensor used.
Flat Power Calibrations	A flat power calibration (when in frequency sweep mode) is available at a user-selectable power level, if it is within the power adjustment range of the internal source. The flat power correction is applied to other power levels directly as an offset. Multiple power meters/sensors may be needed depending on the frequency range. An adapter may be required to the 1mm module test port.
Linear Power Calibrations	A linear power calibration is performed over a range of power levels for use in power sweep mode and is performed at a specified frequency or frequency range (for multifrequency gain compression).
External Power Meter	Both calibrations are performed using an external power meter (Anritsu ML2438A, ML248xB, ML249xA, Agilent 437B (or equivalent), Rhode and Schwarz NRP2 meter with a broadband 110 GHz sensor, or Elva DPM power meter) over the Dedicated GPIB port, or a USB power sensor (Anritsu MA24106A, MA24108A, MA24118A, MA24126A, MA24208A, MA24218A, MA24330A, MA24340A, MA24350A, MA24507A) connected to a USB port.  Note: Usage of the MA24500A series sensor requires a dual USB Type A male to single USB Type A female cable to supply needed current draw.
<b>Embedding/De-embedding</b>	The MS4640B is equipped with an Embedding/De-embedding system.
De-embedding	De-embedding is generally used for removal of test fixture contributions, modeled networks and other networks described by S-parameters (s2p files) from measurements.
Embedding	Similarly, the Embedding function can be used to simulate matching circuits for optimizing amplifier designs or simply adding effects of a known structure to a measurement.
Multiple Networks	Multiple networks can be embedded/de-embedded and changing the port and network orientations is handled easily.
Extraction Utility	An extraction utility is part of this package that allows the easier computation of de-embedding files based on some additional calibration steps and measurements.
<b>Impedance Conversion</b>	Allows entry of different impedances (complex values) for different ports.

## Mechanical Calibration/Verification Kits

**W1 (1 mm) Calibration/Verification Kit, 3656B**

Provides 12-term SOLT or Triple Offset Short calibrations, for W1 (1 mm) devices, and two verification standards. The -3 options adds .s1p standards definition files for reduced calibration-related uncertainties.



3656B Cal Kit Contains:	Additional Information (Typical)	Quantity	Part Number
Offset Short W1 (male)	Offset: 2.020 mm	1	23W50-1
Offset Short W1 (male)	Offset: 2.650 mm	1	23W50-2
Offset Short W1 (male)	Offset: 3.180 mm	1	23W50-5
Offset Short W1 (female)	Offset: 2.020 mm	1	23WF50-1
Offset Short W1 (female)	Offset: 2.650 mm	1	23WF50-2
Offset Short W1 (female)	Offset: 3.180 mm	1	23WF50-5
Open W1 (male)	Offset: 1.510 mm	1	24W50
Open W1 (female)	Offset: 1.930 mm	1	24WF50
Fixed Termination W1 (male)		1	28W50
Fixed Termination W1 (female)		1	28WF50
Adapter, W1 (male) to Fixed SC <sup>a</sup> Connector		1	33W50-50
Adapter, W1 (female) to Fixed SC <sup>a</sup> Connector		1	33WF50-50
Interchangeable Slider for SC <sup>a</sup> Connector (male)		1	-
Interchangeable Slider for SC <sup>a</sup> Connector (female)		1	-
Locking Keys for SC <sup>a</sup> Connectors		2	-
Pin Exchange Tool for SC <sup>a</sup> Connectors	Contains 1 male pin	1	01-402
Adapter, W1 (male) to W1 (female)		1	33WWF50
Adapter, W1 (male) to W1 (male)		1	33WW50
Adapter, W1 (female) to W1 (female)		1	33WFW50
Stepped Impedance ThruLine, W1 (male - female)	Verification Device	1	18WWF50-1B
50 Ω matched ThruLine, W1 (male - female)	Verification Device	1	18WWF50-1
Torque Wrench	6 mm, 5.4 N-cm (4 lbf-in)	1	01-504
Open-ended Wrench	6 mm / 7 mm	1	01-505
Coefficients for standards	On USB Memory Device and 3.5 in Floppy Disk	1	-

a. SC Connectors are a solution for accurate calibrations for non-insertable 1 mm devices. Users can change the gender of the SC connector using the provided tool, pin, sliders, and locking keys to ensure the best pin-depth, thus calibrations are valid after changing the gender of the adapter.

Test Port Cables

Test Port Cables, Flexible, High Performance

Description	Frequency Range	Impedance	Length (cm)	Insertion Loss (dB)	Return Loss (dB)	Part Number
W1 (1 mm) (male) to W1 (1 mm) (female)	DC to 110 GHz	50 Ω	10	1.74	≥ 14	3671W1-50-1
			13	2.23	≥ 14	3671W1-50-2
			16	2.74	≥ 14	3671W1-50-3



3671W1-50-X Flexible Test Cables

Precision Adapters, Attenuators, and Other Components

Anritsu offers a complete line of precision adapters and attenuators. For more information, please visit our web site at [www.anritsu.com](http://www.anritsu.com).



**Ordering Information**

The ME7838E Broadband/Millimeter-Wave VNA System provides single sweep coverage from 70 kHz to 110 GHz and consists of the following standard components and optional accessories described in the sections below:

**ME7838E Broadband System, 70 kHz to 110 GHz**

Action	Part Number and Description	Additional Information
Order the base VectorStar model with the listed components and options:	MS4647B, 70 kHz to 70 GHz VNA MS4640B-007, Receiver Offset MS4640B-070, 70 kHz Frequency Coverage 3739C, Broadband Test Set with 36 inch interface cables 3743E, Millimeter-Wave Module, 2 each ME7838E-SS020, On-site system assembly and verification	
Include one of the following:	MS4647B-086, MS4647B with ME7838E system option	MS4647B-088 is ordered when Option 31 is included
	MS4647B-087, MS4647B with ME7838E system option and Option 51, or 61, or 62	MS4647B-089 is ordered when Option 31 is included
Include one of the following:	806-206-R, 1.85 mm coaxial VNA RF cables, 24", M-F, 2 each	
	806-209-R, 1.85 mm coaxial VNA RF cables, 36", M-F, 2 each	
Add options if desired:	Option 51, or 61, or 62: MS4647B-051 – External VNA Loops MS4647B-061 – Active Measurement Suite, 2 Attenuators MS4647B-062 – Active Measurement Suite, 4 Attenuators	
	MS4640B-070 – for 70 kHz operation in base VNA	
	MS4640B-002 – for Time Domain	
	MS464xB-031 – Dual Source Architecture	MS464xB-031 requires Option 88 or 89
	MS4640B-035 – IF Digitizer	
	MS4640B-041 – Noise Figure	
	MS4640B-042 – PulseView™	
	MS4640B-043 – DifferentialView™	
MS4640B-048 – Differential Noise Figure	For other available options, see <a href="#">“ME7838E Broadband/Millimeter-Wave System Options”</a>	
Accessories	MS4640B-001, MS4640B Rack Mount 3739C-001, 3739C Rack Mount	



## ME7838E Waveguide-Band System to 110 GHz – 3744E-EE or 3744E-EW mm-Wave Modules

Configuration for ME7838E Millimeter-Wave System using 3744E-EE or 3744E-EW mm-Wave Modules:

Action	Part Number and Description	Additional Information
Choose and order one of the two base VectorStar models with options listed:	MS4644B VNA, 10 MHz to 40 GHz MS4640B-007 MS4644B-086 or -087 or -088 or -089	MS4644B-087 is ordered when Option 51, or 61, or 62 is included. MS4644B-088 is ordered when Option 31 is included and Option 51, or 61, or 62 is <i>excluded</i> . MS4644B-089 is ordered when Option 31 <i>and</i> Option 51, or 61, or 62 is <i>included</i> .
	MS4647B VNA, 10 MHz to 70 GHz MS4647B-007 MS4647B-086 or -087 or -088 or -089	MS4647B-087 is ordered when Options 51, 61, or 62 are included. MS4647B-088 is ordered when Option 31 is included and Option 51, or 61, or 62 is <i>excluded</i> . MS4647B-089 is ordered when Option 31 <i>and</i> Option 51, or 61, or 62 is <i>included</i> .
Order Test Set	3739C mm-Wave Test Set	
Choose and order Extended-E or Extended-W Band Modules:	3744A-EE, 56 GHz to 94 GHz Extended E Band module, 2 each	
	3744A-EW, 65 GHz to 110 GHz Extended W Band module, 2 each	
Add options if desired:	Option 51, or 61, or 62: MS464xB-051 – External VNA Loops MS464xB-061 – Active Measurement Suite, 2 Attenuators MS464xB-062 – Active Measurement Suite, 4 Attenuators	
	MS4640B-070 – for 70 kHz operation in base VNA MS4640B-002 – for Time Domain MS464xB-031 – Dual Source Architecture MS4640B-035 – IF Digitizer MS4640B-041 – Noise Figure MS4640B-042 – PulseView™ MS4640B-043 – DifferentialView™ MS4640B-048 – Differential Noise Figure	MS464xB-031 requires Option 88 or 89  For other available options, see <a href="#">“ME7838E Broadband/Millimeter-Wave System Options”</a>
	MS4640B-001, MS4640B Rack Mount 3739C-001, 3739C Rack Mount	
	35WR12WF-EE – Precision Waveguide to Coax Adapter Kit, 56 GHz to 94 GHz, WR-12 to W1 (f)	
	35WR10WF-EW – Precision Waveguide to Coax Adapter Kit, 65 GHz to 110 GHz, WR-10 to W1 (f)	
	Accessories	

**ME7838E-Waveguide-Band System – OML/VDI mm-Wave Modules**

ME7838E Waveguide-band System using OML or VDI Millimeter-Wave modules:

Action	Part Number and Description	Additional Information
Choose and order one of the three base VectorStar models with options listed:	MS4642B VNA, 70 kHz to 20 GHz MS4642B-061 or MS4642B-062 MS4642B-087 or MS4642B-089	MS4642B-061 includes Active Device Measurements, with 2 Step Attenuators MS4642B-062 includes Active Device Measurements, with 4 Step Attenuators MS4642B-089 is ordered when Option 31 is included.
	MS4644B VNA, 10 MHz to 40 GHz MS4640B-007 Receiver Offset MS4644B-086 or -087 or -088 or -089	MS4644B-087 is ordered when Options 51, 61, or 62 are included. MS4644B-088 is ordered when Option 31 is included and Option 51, or 61, or 62 is <i>excluded</i> . MS4644B-089 is ordered when Option 31 <i>and</i> Option 51, or 61, or 62 is <i>included</i> .
	MS4647B VNA, 10 MHz to 70 GHz MS4647B-007 Receiver Offset MS4647B-086 or -087 or -088 or -089	MS4647B-087 is ordered when Options 51, 61, or 62 are included. MS4647B-088 is ordered when Option 31 is <i>included</i> and Option 51, or 61, or 62 is <i>excluded</i> . MS4647B-089 is ordered when Option 31 <i>and</i> Option 51, or 61, or 62 is <i>included</i> .
Order:	3739C mm-Wave Test Set	
	SM6537 Interface Cables (2) for OML/VDI mm-Wave Modules	Does not include DC cable. DC supply is provided by mm-Wave module power supply.
Choose and order one of the two appropriate millimeter-wave module combinations:	2 each TxRx transmission and reflection millimeter-wave modules	Choose appropriate OML or VDI modules. Contact Anritsu Company for ordering information.
	1 each TxRx transmission and reflection module, and 1 each Tx transmission only module	
Add options if desired:	Option 51, or 61, or 62: MS464xB-051 – External VNA Loops MS464xB-061 – Active Measurement Suite, 2 Attenuators MS464xB-062 – Active Measurement Suite, 4 Attenuators	
	MS4640B-070 – for 70 kHz operation in base VNA MS4640B-002 – for Time Domain MS464xB-031 – Dual Source Architecture MS4640B-035 – IF Digitizer MS4640B-041 – Noise Figure MS4640B-042 – PulseView™ MS4640B-043 – DifferentialView™ MS4640B-048 – Differential Noise Figure	MS464xB-031 requires Option 88 or 89  For other available options, see “ <a href="#">ME7838E Broadband/Millimeter-Wave System Options</a> ”

**Calibration/Verification Kits**

- 3656B W1 (1 mm) Calibration/Verification Kit
- 3656B-3 W1 (1 mm) Calibration/Verification Kit, With .s1p Standard Definitions Files
- 3655V WR-15 Waveguide Calibration Kit, Without Sliding Loads
- 3655V-1 WR-15 Waveguide Calibration Kit, With Sliding Loads
- 3655E WR-12 Waveguide Calibration Kit, Without Sliding Loads
- 3655E-1 WR-12 Waveguide Calibration Kit, With Sliding Loads
- 3655W WR-10 Waveguide Calibration Kit, Without Sliding Loads
- 3655W-1 WR-10 Waveguide Calibration Kit, With Sliding Loads
- 3650A SMA/3.5 mm Calibration Kit, Without Sliding Loads
- 3650A-1 SMA/3.5 mm Calibration Kit, With Sliding Loads
- 3652A K Calibration Kit, With Pin Depth Gauge
- 3652A-2 K Calibration Kit, With No Pin Depth Gauge
- 3652A-3 K Calibration Kit, With Pin Depth Gauge and .s1p Characterization Files
- 3652A-4 K Calibration Kit, With .s1p Characterization Files
- 3654D V Calibration Kit, With Pin Depth Gauge
- 3654D-2 V Calibration Kit, With No Pin Depth Gauge
- 3654D-3 V Calibration Kit, With Pin Depth Gauge and .s1p Characterization Files
- 3654D-4 V Calibration Kit, With .s1p Characterization Files
- 3657 V Multi-Line Calibration Kit, Without Shorts
- 3657-1 V Multi-Line Calibration Kit, With Shorts

**External Power Meters/Sensors**

ML243xA	CW Power Meter, Single Input or Dual Input Recommended Power Sensors: SC7770, MA247xD, MA244xD, MA248xD, MA2400xA
ML248xB	Wideband Power Meter, Single Input or Dual Input Recommended Power Sensors: MA249xA, MA2411B
ML249xA	Pulse Power Meter, Single Input or Dual Input Recommended Power Sensors: MA249xA, MA2411B
MA24106A	USB Power Sensor, 50 MHz to 6 GHz
MA24108A	USB Power Sensor, 10 MHz to 8 GHz
MA24118A	USB Power Sensor, 10 MHz to 18 GHz
MA24126A	USB Power Sensor, 10 MHz to 26 GHz
MA24330A	USB Power Sensor, 10 MHz to 33 GHz
MA24340A	USB Power Sensor, 10 MHz to 40 GHz
MA24350A	USB Power Sensor, 10 MHz to 50 GHz
MA24507A	Power Master™ Frequency Selectable mm-Wave Power Analyzer, 9 kHz to 70 GHz
MA24510A	Power Master™ Frequency Selectable mm-Wave Power Analyzer, 9 kHz to 110 GHz Note that usage of the MA24507A or MA24510A Power Master™ sensor requires connection to two USB ports to supply needed current draw.

**Test Port Cables, Flexible, High Performance**

3671W1-50-1	W1 (male) to W1 (female), 1 each, 10.0 cm (3.9 in)
3671W1-50-2	W1 (male) to W1 (female), 1 each, 13.0 cm (5.1 in)
3671W1-50-3	W1 (male) to W1 (female), 1 each, 16.0 cm (6.3 in)
3671KFS50-60	K (female) to 3.5 mm (male) cable, 60 cm (one cable)
3671KFK50-60	K (female) to K (male) cable, 60 cm (one cable)
3671KFK50-100	K (female) to K (male) cable, 1 each, 100 cm (one cable)
3671KFK50-60	K (female) to K (female) cable, 1 each, 60 cm (one cable)
3671VVF50-60	V (female) to V (male) cable, 1 each, 60 cm (one cable)
3671VVF50-100	V (female) to V (male) cable, 1 each, 100 cm (one cable)
3671KFS50-60	K (female) to 3.5 mm (female) cable, 1 each, 60 cm (one cable)
3671VVF50-60	V (female) to V (female) cable, 1 each, 60 cm (one cable)

**Adapters**

34WV50	W1 (male) to V (male) Adapter, W1 (1 mm) to V, Coaxial
34WVF50	W1 (male) to V (female) Adapter, W1 (1 mm) to V, Coaxial
34WV50	W1 (female) to V (male) Adapter, W1 (1 mm) to V, Coaxial
34WVF50	W1 (female) to V (female) Adapter, W1 (1 mm) to V, Coaxial
33WW50	W1 (male) to W1 (male) Adapter, W1 (1 mm) in-series, Coaxial
33WWF50	W1 (male) to W1 (female) Adapter, W1 (1 mm) in-series, Coaxial
33WV50	W1 (female) to W1 (male) Adapter, W1 (1 mm) in-series, Coaxial
33WVF50	W1 (female) to W1 (female) Adapter, W1 (1 mm) in-series, Coaxial
35WR10W	WR10 to W1 (male) Adapter, W1 (1mm) to WR10 Waveguide
35WR10WF	WR10 to W1 (female) Adapter, W1 (1mm) to WR10 Waveguide
SC7260	WR12 to W1 (male) Adapter, W1 (1 mm) to WR12 Waveguide
SC7442	WR12 to W1 (female) Adapter, W1 (1 mm) to WR12 Waveguide
35WR15V	WR15 to V (male) Adapter, V (1.85mm) to WR15 Waveguide
35WR15VF	WR15 to V (female) Adapter, V (1.85mm) to WR15 Waveguide
For More Information	Refer to our <b>Precision RF &amp; Microwave Components Catalog</b> for descriptions of adapters and other components.

**Miscellaneous Components**

41W-3	Attenuator, DC to 110 GHz, 0.2 W, 3 dB, W1(m) to W1(f), 50 Ω
41W-6	Attenuator, DC to 110 GHz, 0.2 W, 6 dB, W1(m) to W1(f), 50 Ω
41W-10	Attenuator, DC to 110 GHz, 0.2 W, 10 dB, W1(m) to W1(f), 50 Ω
W240A	Precision Power Divider, DC to 110 GHz, W1(f) input, W1(f) outputs, 3 resistor, 50 Ω
W241A	Precision Power Splitter, DC to 110 GHz, W1(m) input, W1(f) outputs, 2 resistor, 50 Ω
MN25110A	Precision Directional Coupler, 20 GHz to 110 GHz, W1(f) input, W1(f) output, W1(f) coupled port, 50 Ω

**Accessories**

SC8215	Kelvin Bias Tee, low frequency limit: 70 kHz, Max Voltage: 16 VDC, Max Current: 100 mA
SC7287	Kelvin Bias Tee, low frequency limit: 100 MHz, Max Voltage: 50 VDC, Max Current: 500 mA
SC8218	Triax (male) to SMC (female) Cable, (Inner-shield floating at SMC end), 1.5 m (60 in) long two (2) needed per Kelvin Bias Tee
SM6494	System floor console. Includes larger size writing table
2100-1	GPIB cable, 1 m (39 in) long
2100-2	GPIB cable, 2 m (79 in) long
2100-4	GPIB cable, 4 m (157 in) long
806-206-R	Flexible Coaxial Cable, DC to 70 GHz, 24 in (61 cm), V(m) – V(f), 50Ω for connecting the VNA and the 3743A Modules
806-209-R	Flexible Coaxial Cable, DC to 70 GHz, 36 in (91.5 cm), V(m) – V(f), 50Ω for connecting the VNA and the 3743A Modules
01-201	Torque Wrench (for tightening male devices), 8 mm (5/16 in), 0.9 N·m (8 lbf·in) for SMA, 3.5 mm, 2.4 mm, K, and V connectors
01-202	Universal Test Port Connector Wrench
01-203	Torque Wrench (for tightening the VNA test ports to female devices) 20.6 mm (13/16 in), 0.9 N·m (8 lbf·in)
01-204	Anritsu Stainless Steel Connector Wrench, circular, open-ended for SMA, 3.5 mm, 2.4 mm, K and V connectors
01-504	Torque wrench (for tightening male devices) 6 mm, 0.45 N·m (4 lbf·in) for 1.0 mm and 0.8 mm connectors
01-524	Low profile Torque Wrench (for tightening male devices), 6 mm, 0.45 N·m (4 lbf·in), 126 mm long for 1.0 mm and 0.8 mm connectors
01-529-R	Torque Wrench, 4 mm (5/32 in), 0.17 N·m (1.5 lbf·in) (for tightening the test and reference IF connectors on the mm-Wave modules)



ООО «4ТЕСТ»

Телефон: +7 (499) 685-4444

info@4test.ru

[www.4test.ru](http://www.4test.ru)